

MAESTRO

POWERED BY OVERSEER

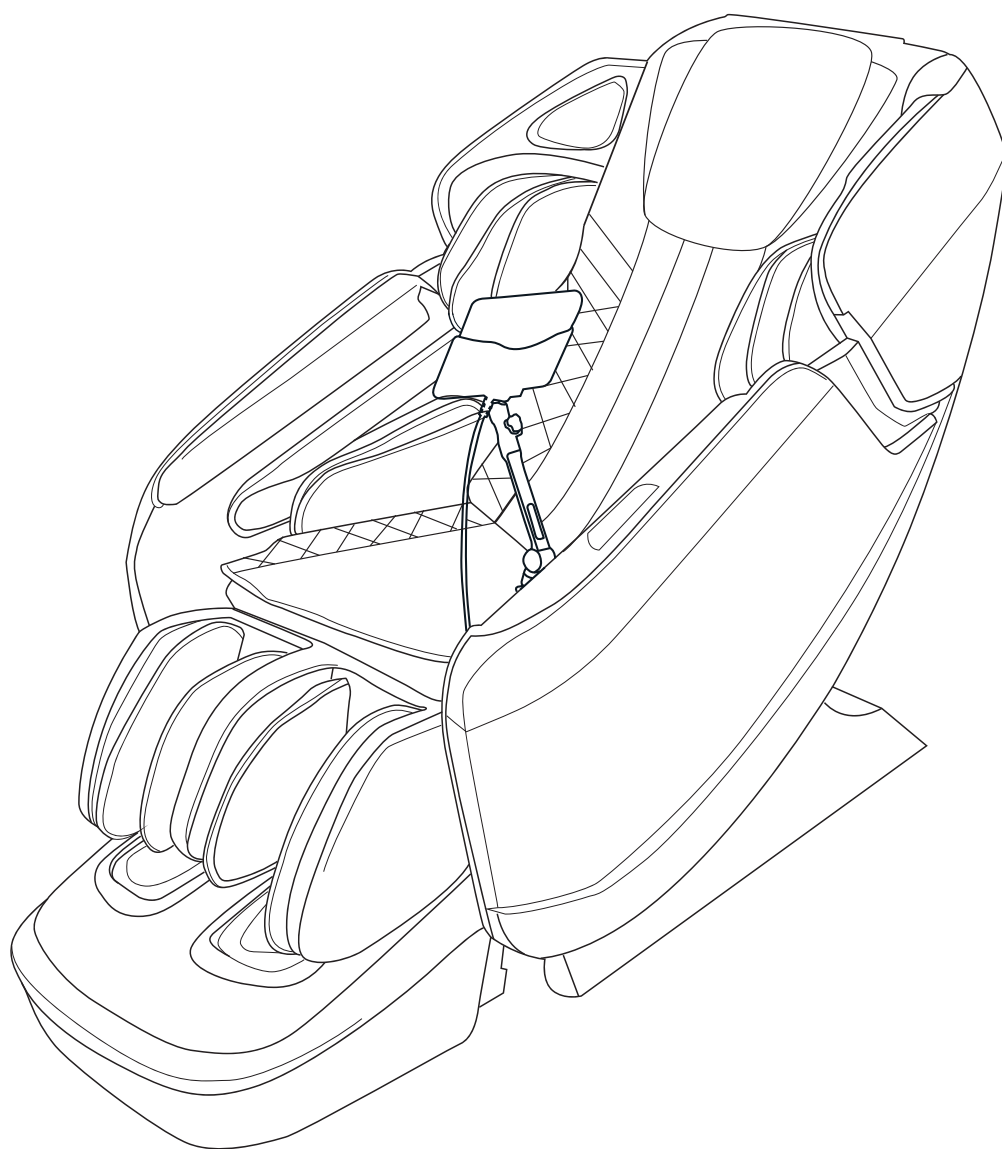

User Manual
OG7599 使用手册

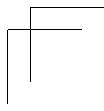
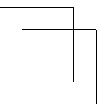
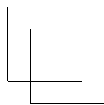
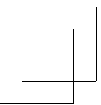

MAESTRO

POWERED BY OVERSEER

User Manual
All information is correct at the time of print

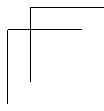
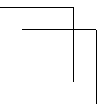
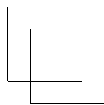
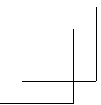

Contents

Before Use

● Important safety instructions	EN1
● Grounding instructions	EN5
● Product parts	EN6
● Setup of the massage lounger	EN8
● Assembly	EN9
● Before use	EN10

How to Use

● Introduction to Psychotherapy	EN14
● Short Cut Button Operation	EN15
● Operation Guide	EN16
● After massage	EN25

Maintenance

● Cleaning and maintenance	EN27
---	------

Q&A/Important notes



● Q&A	EN28
● Troubleshooting	EN29
● Specification	EN31
● Customer Support Guidelines	EN32
● Contact Us	EN33

Important safety instructions

Must be followed



These safety instructions must be strictly followed in use to avoid personal injuries and property damage are as follows:

■ All the safety instructions are described in compliance with degrees of the injuries or damage as a result of wrong use.





 Warning	Actions tending to cause serious injuries or death
 Caution	Actions tending to cause minor injuries or property damage

■ Pay attention to the symbols before safety instructions (an example is given below).



 Actions that must be absolutely forbidden	 Actions that must be done
--	---

 Warning															
 Must be followed	<ul style="list-style-type: none"> ● Before using the product, persons who are being treated or have any of the following symptoms should consult a physician. <table border="0"> <tr> <td>(1) Persons with a pacemaker or another in-vivo electronic medical device tending to suffer electronic jamming;</td> <td>(8) Persons with injuries in the massaged parts;</td> </tr> <tr> <td>(2) Patients with malignant tumors;</td> <td>(9) Persons with a body temperature above 38 °C (with a fever) (For example, persons with intense acute inflammation symptoms such as listlessness, cold shivers and blood pressure change or persons in poor health);</td> </tr> <tr> <td>(3) Patients with heart disease;</td> <td>(10) Persons who are unwell or must have a rest;</td> </tr> <tr> <td>(4) Persons proved to be unable to identify temperatures;</td> <td>(11) Persons with an abnormal or bent vertebra;</td> </tr> <tr> <td>(5) Pregnant persons or women who have just had childbirth;</td> <td>(12) Persons with protrusion of intervertebral disc;</td> </tr> <tr> <td>(6) Persons with perceptual disturbance because of diabetes or another serious peripheral circulation disturbance;</td> <td>(13) Persons who feel very uncomfortable (except for the circumstances above)</td> </tr> <tr> <td>(7) Osteoporosis patients, spinal fracture patients, or persons with acute painful diseases such as sprains or muscle strains;</td> <td></td> </tr> </table> <p>Otherwise accidents or physical discomfort may happen.</p> ● If you feel physically abnormal while using or no effect after use, stop the product immediately and consult a physician about it. Otherwise accidents or physical discomfort may happen. ● Before being massaged or moving the backrest or the Lower Leg/Foot massage section, make sure there is no person or pet close to the product (in front, behind, below or on the side). ● Before use, make sure there is no foreign matter between the backrest and the back cover. Otherwise accidents or physical discomfort may happen. ● Before use, lift the back cushion and check whether fabric of traveling sections of the massage wheels or of other positions are damaged. (Even if the fabric is slightly damaged, stop the product immediately, pull out the power plug and send the product to repair.) If the product is used when the fabric is damaged, you may get injured or get an electric shock. ● Please ensure no object surrounding the chair before turn ON / OFF ● Do not massage for more than 30 minutes each time. ● Do not massage a single part for more than 5 minutes. If any of these safety instructions is not followed, you may suffer an adverse effect and be injured. ● After use each time, turn the power switch to the “O” position ,and then pull out the power plug. Otherwise accidents or injuries may happen due to naughty behaviors of children. ● Follow the regulations about use of the socket and the wiring devices. ● Use a 220-240V~,50/60Hz power supply. (Do not use the product in a foreign country or connect it with a transformer without permission.) Otherwise electric shocks, product faults or fires because of overheat may happen. ● Insert the power plug thoroughly into the socket. Otherwise electric shocks or fires caused by overheat may happen. ● Remove such dirt as dust on the power plug at regular intervals. Otherwise fires caused by poor insulation due to factors such as moisture may happen. (Wipe the power plug with dry cloth.) 	(1) Persons with a pacemaker or another in-vivo electronic medical device tending to suffer electronic jamming;	(8) Persons with injuries in the massaged parts;	(2) Patients with malignant tumors;	(9) Persons with a body temperature above 38 °C (with a fever) (For example, persons with intense acute inflammation symptoms such as listlessness, cold shivers and blood pressure change or persons in poor health);	(3) Patients with heart disease;	(10) Persons who are unwell or must have a rest;	(4) Persons proved to be unable to identify temperatures;	(11) Persons with an abnormal or bent vertebra;	(5) Pregnant persons or women who have just had childbirth;	(12) Persons with protrusion of intervertebral disc;	(6) Persons with perceptual disturbance because of diabetes or another serious peripheral circulation disturbance;	(13) Persons who feel very uncomfortable (except for the circumstances above)	(7) Osteoporosis patients, spinal fracture patients, or persons with acute painful diseases such as sprains or muscle strains;	
	(1) Persons with a pacemaker or another in-vivo electronic medical device tending to suffer electronic jamming;	(8) Persons with injuries in the massaged parts;													
	(2) Patients with malignant tumors;	(9) Persons with a body temperature above 38 °C (with a fever) (For example, persons with intense acute inflammation symptoms such as listlessness, cold shivers and blood pressure change or persons in poor health);													
	(3) Patients with heart disease;	(10) Persons who are unwell or must have a rest;													
	(4) Persons proved to be unable to identify temperatures;	(11) Persons with an abnormal or bent vertebra;													
	(5) Pregnant persons or women who have just had childbirth;	(12) Persons with protrusion of intervertebral disc;													
	(6) Persons with perceptual disturbance because of diabetes or another serious peripheral circulation disturbance;	(13) Persons who feel very uncomfortable (except for the circumstances above)													
	(7) Osteoporosis patients, spinal fracture patients, or persons with acute painful diseases such as sprains or muscle strains;														





Warning

 Must be followed	<ul style="list-style-type: none"> ● In the case of any abnormality or fault, stop the product immediately and pull out the power plug to avoid smoke, fires and electric shocks. Abnormality and fault examples <ul style="list-style-type: none"> • The product fails to work after the power switch is turned to the ON position; • After the power line is moved, the product is discontinuously powered on; • In use, the product gives off a burning smell or an abnormal sound; • The product is deformed or abnormally heating; → In any of these abnormalities and faults, have the product inspected and repaired by an authorized service center immediately.
 Forbidden	<ul style="list-style-type: none"> ● Do not put the back cushion between the backrest and the back cover. Otherwise product faults may happen. ● When handling the product, hold its frame. Otherwise product faults or personal injuries may happen. ● The following persons should not use the product. Persons for whom massage is forbidden by doctors, such as persons with thrombosis, serious aneurysm, acute venous aneurysm, various skin inflammations (such as subcutaneous tissue inflammation) or various skin infections. Otherwise diseases may get worse. ● The following persons should not massage their waists. <ul style="list-style-type: none"> • Persons with acute lumbago, protrusion of intervertebral disc, or displacement of a lumbar vertebra; • Persons with deformation or other discomfort of the hip joint; Otherwise diseases may get worse. ● Do not put hands, arms or feet into the backrest's fabrics of traveling sections of the massage wheels. ● Children should not use the product. Keep them from playing on the product or climbing onto the Lower Leg/Foot massage section, the seat, the backrest or the armrests. ● Do not climb onto the backrest or the armrests. ● Do not lean or sit on the backrest. ● Keep your head from reachable areas of the backrest and the back cover. ● Persons unable to express themselves clearly or unable to operate the product should not use the product. ● When massing the neck, pay attention to moving directions of the massage wheels and do not massage with a too large force or massage front part of the neck. Otherwise accidents or personal injuries may happen. ● Do not damage the power line or the power plug. (Do not damage, machine, forcedly bend, twist or prolong the power line or the power plug, or place the power line or the power plug close to a heater, or tie or bind any heavy objects on the power line or the power plug.) A damaged power line or power plug may result in electric shocks, short circuit faults or fires. Please consult the shop from which you bought the product or a designated authorized service center about maintenance method of the power line or the power plug. ● When using the Warm massage wheels, avoid longtime contact with the skin in one position. ● Do not use the Knee Warm massage for a long time. Otherwise you may get low-heat burns. *Even if the temperature is relatively lower (40 °C~ 60 °C), low-heat burns may happen after longtime contact with skin (in spite of no obvious hot or painful feeling). ● Do not damage the Knee Warm (heater) section. <ul style="list-style-type: none"> • Do not insert pins or needles into the product. • Do not cut the product with a cutter. If the internal heater is damaged, fires or electric shocks may happen.
 Wet-hand operation forbidden	<ul style="list-style-type: none"> ● Do not insert or pull out the power plug with wet hands. Otherwise electric shocks may happen.
 Disassembly forbidden	<ul style="list-style-type: none"> ● Do not refit, disassemble or repair the product without permission. Otherwise fires, abnormal movements or personal injuries may happen.

Caution

 Must be followed	<ul style="list-style-type: none"> ● The following persons (even if they are physically healthy at present) should consult a physician before using the product. <ol style="list-style-type: none"> (1) Persons with muscular atrophy due to aging or thin persons; (2) Persons feeling lumbago because of bone or viscus problems; (3) Persons tending to suffer sprains or bruising; (4) Persons with carsickness or seasickness or strong response when taking other transport means; (5) Persons who once received a heart operation or another visceral operation; Otherwise health may get worse.
	<ul style="list-style-type: none"> ● Before sitting on the product, make sure there is no foreign matter between any two parts of it. (Make sure there is no foreign matter on the back cover, the backrest, the seat surface, the Lower Leg/Foot massage section or inside surface of the back cushion.) Otherwise accidents, injuries, or product faults caused by clamping of hands, feet, or other articles by the product may happen.
	<ul style="list-style-type: none"> ● Do not use the product when wearing any hard decorative article on head (such as hair pin). ● If there is any hard article (such as mobile phone or key) in a pocket of the trousers, take it out before massage. ● Before hand or arm massage, remove watch, nail wrap, ring, etc. Otherwise injuries may happen.
	<ul style="list-style-type: none"> ● Before sitting on the seat, make sure the massage wheels are in the retracting positions. ● If you want to leave the seat during the massage, stop the product first. Otherwise accidents or injuries may happen.
	<ul style="list-style-type: none"> ● When pulling out the power plug, do not pull the power line but hold the power plug. Otherwise an electric shock or a short circuit fault may happen.
	<ul style="list-style-type: none"> ● Before moving the product, make the Lower Leg/Foot massage section back to the original position by adjusting its angle. Otherwise injuries may happen.
	<ul style="list-style-type: none"> ● When moving the product by pulleys, put articles such as mats on the floor. Otherwise marks may be left on the floor.
	<ul style="list-style-type: none"> ● Keep children from the retaining screws on the remote controller holder. Otherwise children may cause accidents or suffer injuries by eating it or playing with it.
	<ul style="list-style-type: none"> ● Before moving the product by pulleys, remove the obstructions close to it. Lift the seat surface of the Lower Leg/Foot massage section to a position a little lower than the waist and move the product slowly. Otherwise accidents or injuries may happen because of turnover of the product.
	<ul style="list-style-type: none"> ● In use, place the product horizontally. Otherwise accidents due to turnover of the product may happen.
	<ul style="list-style-type: none"> ● If any symptom such as skin inflammation, itching or swelling in use, stop the product immediately and consult a physician. Otherwise accidents or physical discomfort may happen.
	<ul style="list-style-type: none"> ● If the product is used again for massage after a period of out-of-service, read the Operating Instructions again and make sure the product can run normally first. Otherwise accidents or injuries may happen.
 Forbidden	<ul style="list-style-type: none"> ● Do not use the product and other devices at the same time. Otherwise accidents or physical discomfort may happen.
	<ul style="list-style-type: none"> ● Keep head, abdomen or skin from the massage wheels and do not put hands or feet between the massage wheels. ● Do not put the knees between the Lower Leg/Foot massage section. ● Do not fall asleep while using the product. Do not use the product after drinking. ● If air in the filling the air bag on the seat is not completely discharged, do not stand or jump on the seat or put things on it. Otherwise accidents or injuries may happen.

Caution

 Forbidden	<ul style="list-style-type: none"> ● Do not put hands or feet between the product and the Lower Leg/Foot massage section. ● Do not put hands, arms, or head into the seam of the Lower Leg/Foot massage section (footrest). For safety, admit the Lower Leg/Foot massage section after massage. ● Do not put hands, feet or head between the backrest and the back cover. ● Do not put pets on the product (such as its back cover, backrest and armrest). ● Do not pull out the power plug or turn OFF the power switch suddenly during massage. Otherwise injuries may happen.
	<ul style="list-style-type: none"> ● Do not stand or sit on the back cover. Otherwise personal injuries due to the product toppling may occur.
	<ul style="list-style-type: none"> ● Do not stand or sit on the armrests. Otherwise personal injuries may happen.
	<ul style="list-style-type: none"> ● Do not stand or sit on the Lower Leg/Foot massage section or the footrest. Otherwise accidents or injuries due to rotation of front of the footrest or turnover of the product may happen. If bottom of the Lower Leg/Foot massage section runs into the floor, the floor may be damaged.
	<ul style="list-style-type: none"> ● Do not drag or push the product after it is installed. Otherwise the floor may be damaged.
	<ul style="list-style-type: none"> ● Do not move the product while there is a person on it. Otherwise, accidents, or injuries may happen due to a toppling of the product.
	<ul style="list-style-type: none"> ● Do not use the product on heating devices such as electric blankets. Otherwise fires may happen.
	<ul style="list-style-type: none"> ● Do not put the remote controller on the product. Otherwise the product may be damaged. ● People over 100kg are not advise to use this device ● Please be cautious of using the Brain Massage feature on high volume for extended periods of time
 Wet-hand contact forbidden	<ul style="list-style-type: none"> ● Do not use the product in a bathroom or another wet place. Otherwise electric shocks or product faults may happen.
 Product wetting forbidden	<ul style="list-style-type: none"> ● Do not sprinkle substances such as water on the product or its remote controller. Otherwise electric shocks, short circuit, or product faults may happen.
 Pull out the power plug	<ul style="list-style-type: none"> ● Before cleaning or maintaining the product, pull out the power plug first. Otherwise electric shocks or injuries may happen. ● In the case of a power failure, pull out the power plug at once. Otherwise accidents or injuries may happen when power is restored. ● When the product is not used, pull out the power plug. Otherwise electric leakage fires may happen because of insulation aging caused by dust and moisture.

Grounding instructions

- The product must be grounded to reduce the electric shock hazard because of functional faults of the product.
- The product has a power line with a grounding conductor and a grounding plug. The grounding plug must be inserted into an appropriate socket that has been correctly installed and grounded in full compliance with the local code and decree.

Caution

- If the grounding conductor is not correctly connected, electric shocks may happen. If you are not sure about correctness of the grounding, have it inspected by a professional electrician. Even if the grounding plug provided with the product does not match with the socket you have, do not refit it by yourself but ask a professional electrician to install an appropriate socket.
- The product has a grounding plug. Make sure the product is connected with a socket matching with shape of the grounding plug.
Do not connect the product to a multi-plug.
- If the power plug is damage, it must be replaced by a special plug available from OGAWA or authorize agents.

Important: The product image or content descriptions may slightly differ due to product quality improvement.

- The appliance is not to be used by persons (including children) with reduced physical, sensory or mental capabilities, or lack of experience and knowledge, unless they have been given supervision or instruction.
- Children being supervised not to play with the appliance.
- The appliance has a heated surface. Persons insensitive to heat must be careful when using the appliance.

This user manual is also can be download via internet: www.ogawa.com.cn.

Product Parts

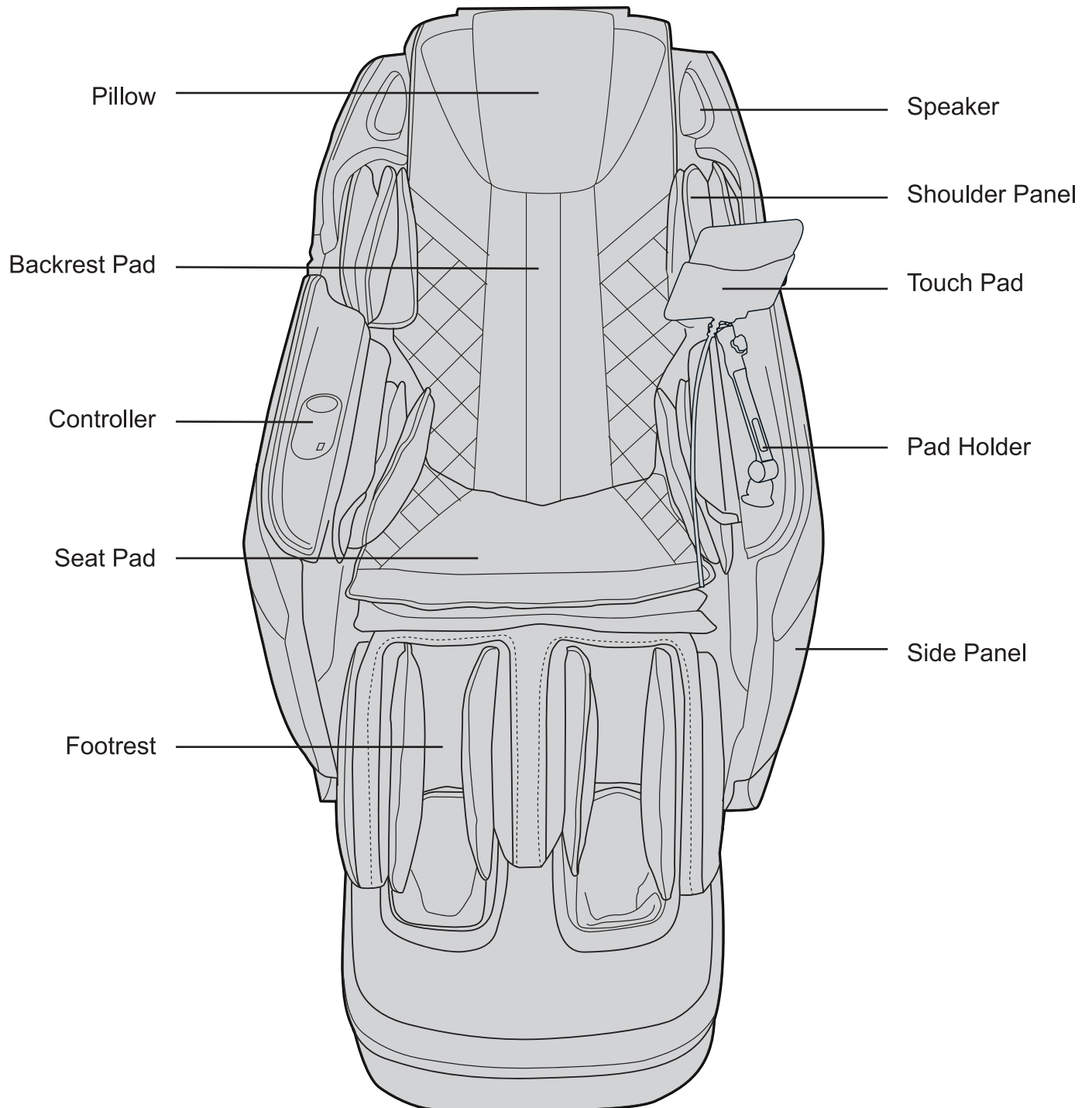

Product Parts

Air Bags Massage Position

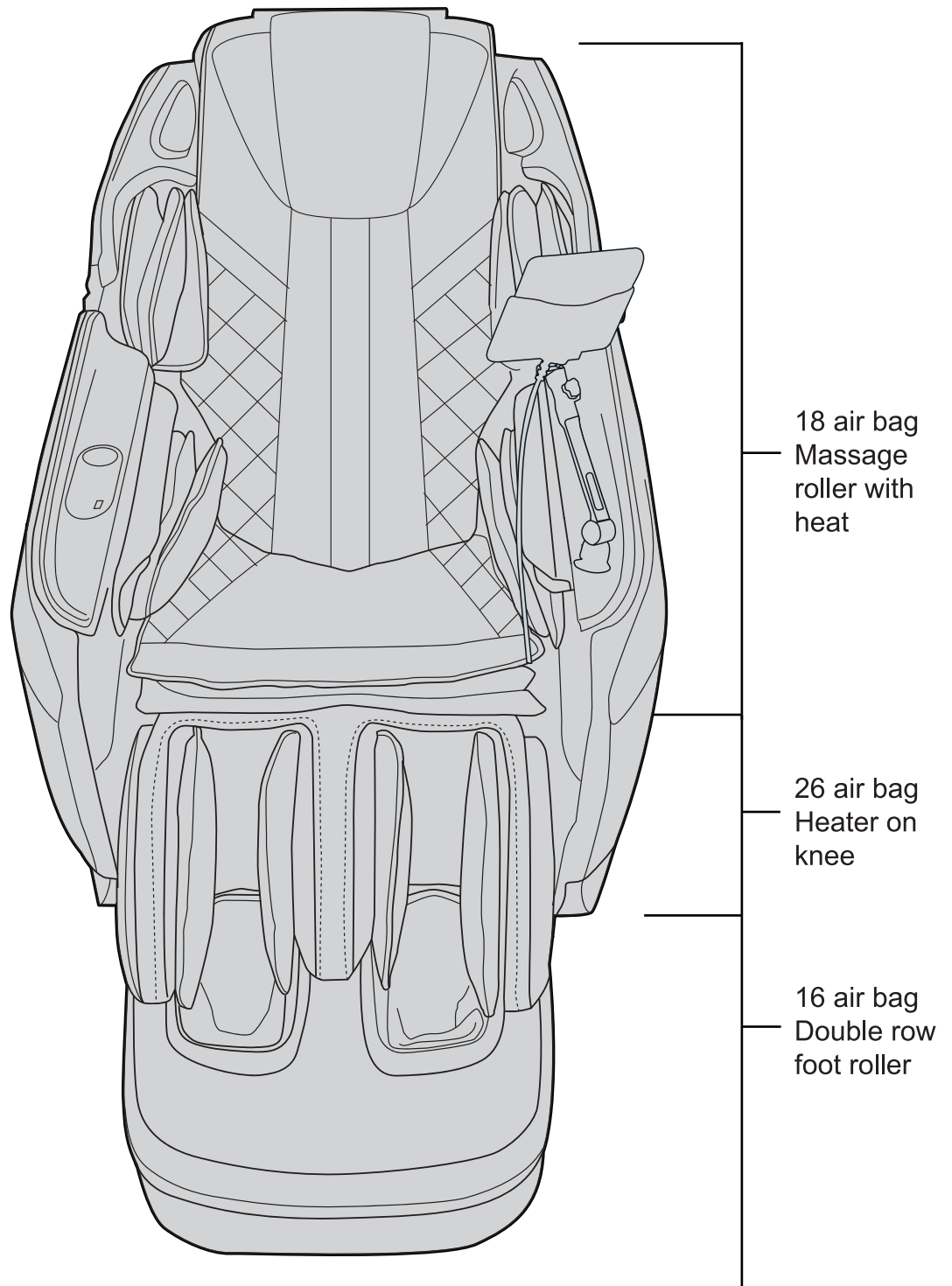

Setup of the massage lounger

1 Before use (installation position)

- Make sure there is enough space for the tilting of the product.

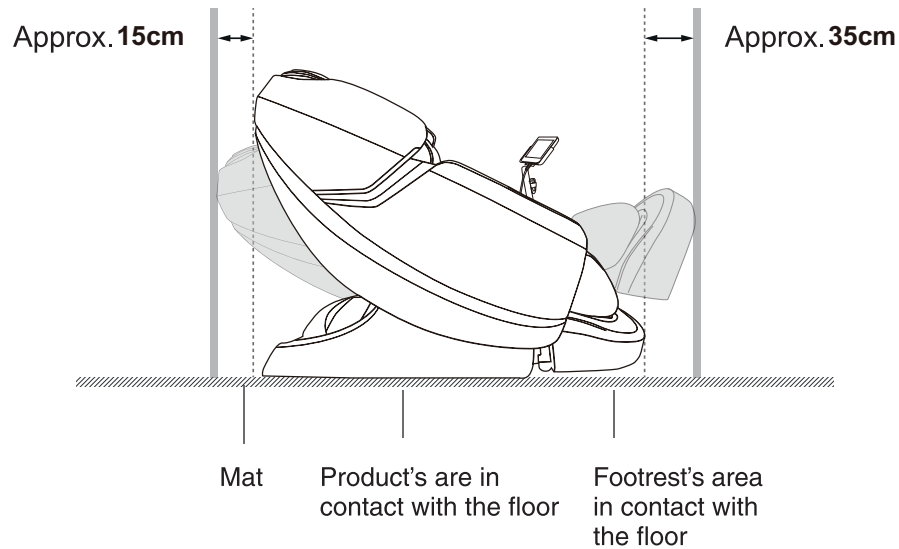

- Do not expose the product to direct sunlight or a high-temperature place (e.g., in front of heating equipment); otherwise its synthetic leather may fade or harden.
- Place a mat below the product to avoid floor damage. The mat should cover the product's area in contact with the floor and the footrest's area in contact with the floor (minimum dimensions: 200cm × 90cm). See the figure.
- Install the product close to a power socket.

2 Chair Moving Instruction

Method one: Hold the two side cover and lift up to moving

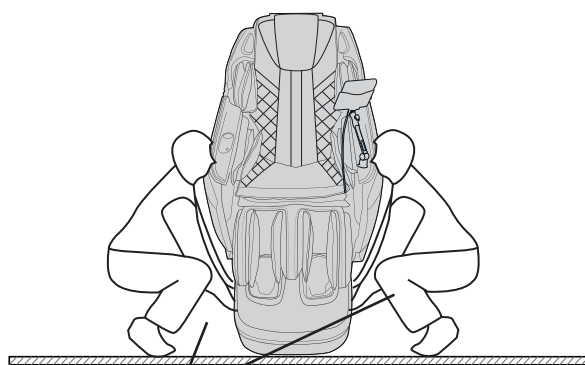

Please lift up the side cover, as the moving process might have scratches on the floor surface.

※**Caution**
Do not put hands at the ridge of channel to avoid the side cover digging out.

- The product is heavy and should be handled carefully by two persons at least to avoid back strain.

Product weight	Approx. 116 kg
----------------	----------------

Put the product on the floor.

- Put down the product slowly and carefully to avoid foot injury.
- Do not release the footrest until the product is placed horizontally. Otherwise the footrest will rebound to its original position.
- It is suggested to pave an article such as a mat on the floor to keep it from damage.

Caution

- | | |
|---|---|
| <ul style="list-style-type: none">● Do not drag or pull the product after it is installed.● When handling the product, do not hold its frame.
Otherwise product faults or personal injuries may happen.● Do not move the product by pulleys directly on a floor.
Otherwise marks may be left on the floor. | <ul style="list-style-type: none">● Do not move the product while there is a person on it.
Otherwise, accidents or injuries may happen due to falling down.● Do not hold the foot massage section when moving the product.
Otherwise injuries may happen due to sliding. |
|---|---|

Method two: Moving by using slip bar underneath

Caution

Moving the massage chair with a slight pull or push as right figure, this way do not fit for the wood floor. Otherwise marks may be left on the floor.

- 1** Press the ON/OFF button to return the back rest and footrest to its original position.
- 2** Slide the power switch to the “O” position and unplug the unit.

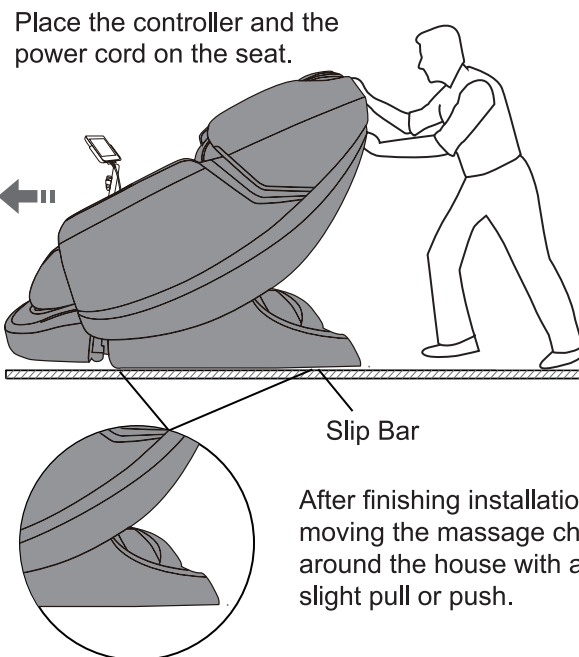

Assembly

(Please refer to the chair installation manual)

Before use

1 Check the space around the product.

Make sure there is no person, pet or other object close to the product.

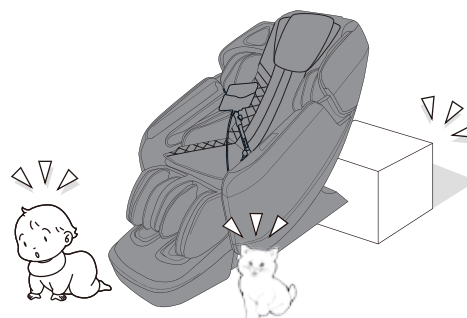

2 Roll up the back cushion and fix it by the zipper.

Roll up the back cushion and fix it on the main body by the zipper.

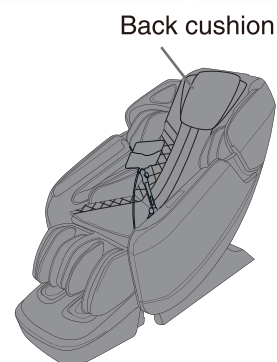

3 Make sure there is no foreign matter in the seams of the product.

When checking the Lower Leg/Foot massage section, press the footrest forward by your hands and make sure there is no foreign matter in the seam.

Caution

- Do not put hands, fingers, feet or head into the seam(s) between the footrest and the seat surface or the armrests.
- Before sitting on the product, make sure there is no foreign matter between any two parts of it.
- Do not put hands, arms or head between the backrest and the back cover.
- Do not put pets on the product (such as its back cover, backrest and armrests).

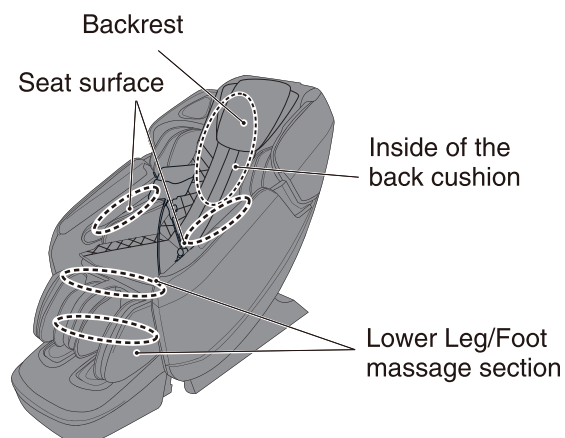

4 Inspect the power line and power plug

Warning

- **Remove such dirt as dust on the power plug at regular intervals.**
Otherwise fires caused by poor insulation due to factors such as moisture may happen. (Wipe the power plug with dry cloth.)
- **Do not damage the power line or the power plug. Do not damage, machine, forcibly bend, twist or lengthen the power line or the power plug, or place the power line or the power plug close to a heater, or tie or bind any heavy objects on the power line or the power plug.**
A damaged power line or power plug may result in electric shocks, short circuits, or fires.
Please consult the shop you bought the product or an authorized service center about maintenance method of the power line or the power plug.

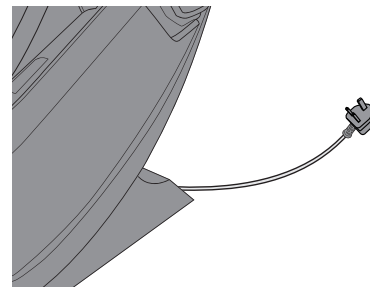

Do not be entangled by the power line.

Push the interface into the power input jack till the end.

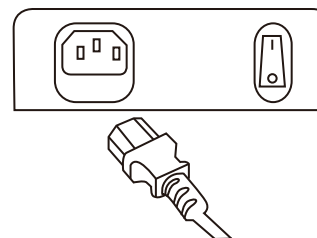

5 Power on the product

- 1 **Insert the power plug into the power socket.**
- 2 **Pull the power switch to the “I” position.**

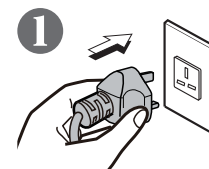

Warning

- **Insert the power plug into the power socket till the end.**
Otherwise electric shocks or fires because of overheat may happen.
- **Abide by the regulations on use of the socket and the wiring devices strictly.**
- **Use a 220-240V~,50-60Hz power supply.**
(Do not use the product in a foreign country or connect it with a transformer without permission.)
Otherwise electric shocks, product faults or fires because of overeat may happen.
- **Do not insert or pull out the power plug with wet hands.**
Otherwise an electric shock may happen.

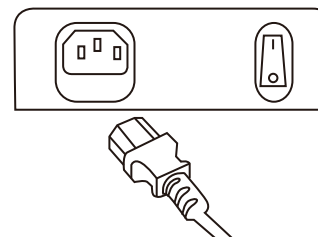

Before use (Continued)

6 Make sure the massage wheels are retracted

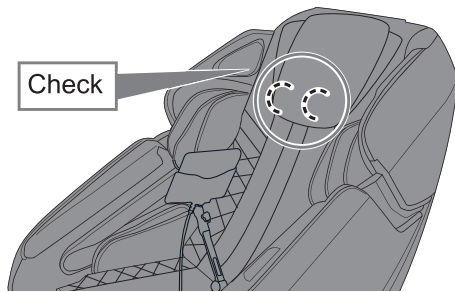

If they are not,

press ON return them to the retracting position.

7 Make sure the fabric is not damaged nor cracked

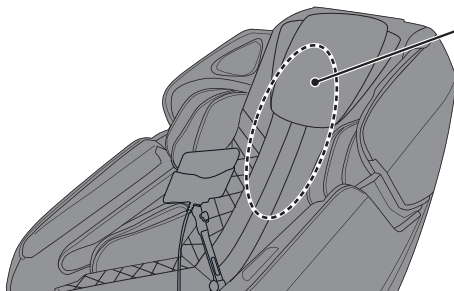

Inspected area:
The fabric of traveling sections of the massage wheels on the backrest

Warning

- Before use, raise the back cushion and check whether fabrics of the area pointed out in the figure are damaged.
(Even if the fabric is slightly damaged, stop the product immediately, pull out the power plug and send the product to repair.)
If the product is used when there is fabric damage, you may get injured or get an electric shock.

8 Adjust the lounger as needed

Adjustment of remote controller

Left-right adjustment.

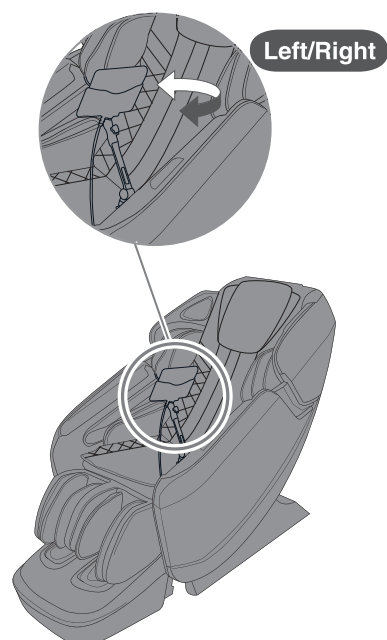

9 Adjust length of the foot massage section as needed

For a tall man

Auto adjust length of the foot massage section to prevent knees from hanging.

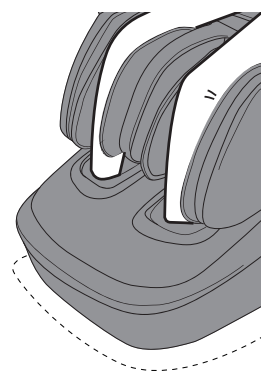

Step the sensor under heel when auto adjust reach comfortable length to stop the adjustment.

Introduction to Psychotherapy

MAESTRO

POWERED BY OVERSEER

Brain Rested with Binaural Beat - Lead to Improve Productivity

OGAWA exclusive massage mode combines massaging and binaural beat healing music to improve brain activity. Binaural beats : A third sound is created in the brain when two sound with varying frequencies enters the ears. This third sound goes in accordance with the brainwaves to allow a deeper state of relaxation and heighten concentration.

Type of Brain Waves	Features
δ	Deep sleep, Healing
θ	Deep Relaxation, Meditation
α	Relaxed focus, Accelerated learning, stress reduction
β	Focused attention, analytical thinking and problem solving

Brain Rested with Light Therapy - Lead to Improve Sleep Quality

OGAWA exclusive massage mode combines with red light. Red light wavelengths stimulate the production of melatonin. Melatonin is a naturally occurring hormone that helps you sleep. Your brain releases more melatonin as darkness falls and tends to release less when you're exposed to light.

Brain Rested with Negative Ions - Lead to Stress Relieve

OGAWA exclusive massage mode combines with negative ions. Think mountains, waterfalls, and beaches. Once they reach our bloodstream, negative ions are believed to produce biochemical reactions that increase levels of the mood chemical serotonin, helping to alleviate depression, relieve stress, and boost our daytime energy.

Short Cut Button Operation

Short cut button on RH side panel, the function available as below :

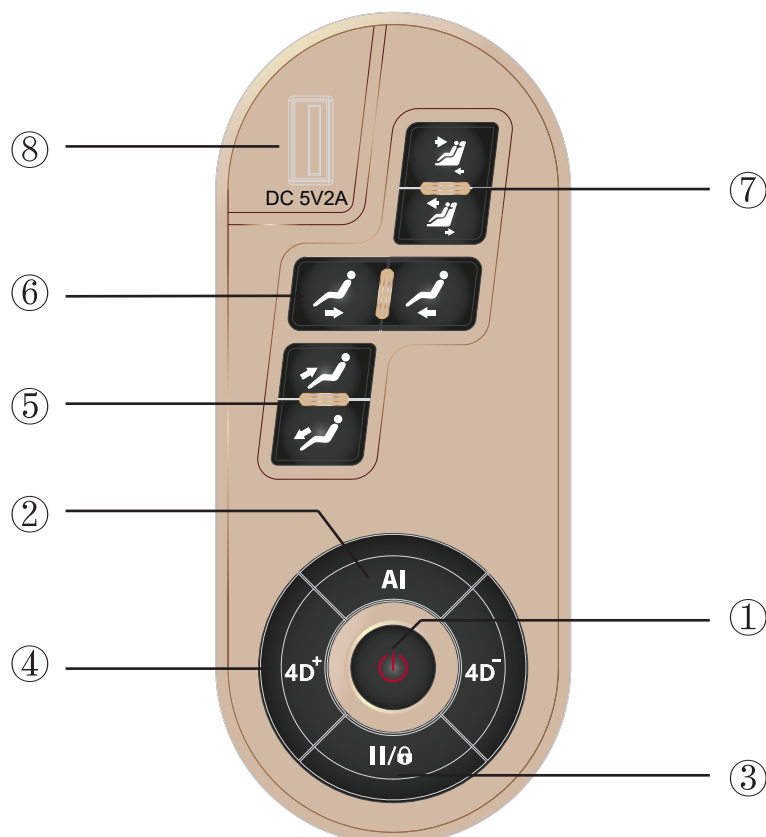

- | | |
|-------------------------------|--|
| 1. [Power] | Press this button to activate the massage chair. Press again to turn OFF. |
| 2. [AI] | When [AI] button is pressed, the AI Fatigue tracker will be turn on.
Press and hold to turn off the voice command.
Press and hold for 5 second to turn OFF the voice command. To turn ON, press and hold for 5 second. |
| 3. [Pause] | Press [Pause] button, all the massage function will temporary stop, press again to resume the massage program. |
| [Child Lock] | Hold down the button for 5 second, the child lock will activate.
To unlock, hold down the button for 5 second. |
| 4. [4D strength] | Press [+] button to increase the 4D level. Press [-] button to reduce the 4D level.
Neck and shoulder max 5 level to be adjust.
Waist and butt max 3 level to be adjust. |
| 5. [Footrest Extend/Retract] | Press lower button for footrest to extend.
Press upper button for footrest to retract. |
| 6. [Footrest Incline/Recline] | Press left button for footrest to recline.
Press right button for footrest to incline. |
| 7. [Backrest Incline/Recline] | Press lower button for backrest to recline.
Press the upper button for backrest to incline. |
| 8. [USB Port] | USB port for mobile phone charging |

Product Operation Guide

Please take note on below information when using this product:

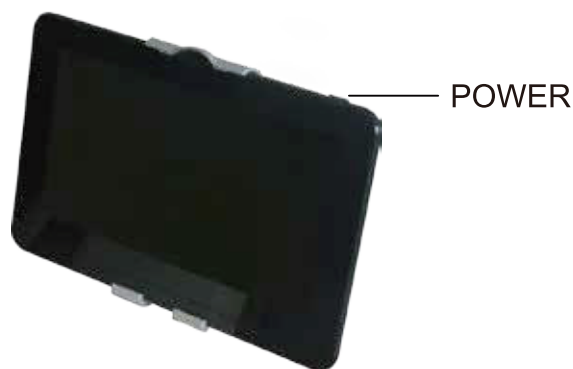

1. Connect the power plug into the socket, turn the switch to "I" position.
2. Press the [POWER] button on the top RH to switch ON the massager chair.
3. Press the [POWER] button to shut off the massager chair after massage complete. Massage roller, footrest and backrest will return back to the origin position. Turn the switch to "O" position and unplug from socket.

1.Menu Screen

The menu screen will appear when the ON/OFF button is pressed.



10 main options with appear :

- [Setting] Refer to icon 1. This page allow user to select language, voice volume, brightness and screen sleep timing
- [Bluettoth] The bluetooth ON/OFF button
- [Pause] Press to temporary stop the massage, press again to resume the massage
- [Exclusive] OGAWA customized program - Master Choice , Rhythmical Massage, Breath Relaxation, AI Fatigue Tracker
- [5 Element] OGAWA customized program - Metal, wood, water, fire, Earth
- [Auto] Psychotherapy - Brain massage - soothing, Brain massage - Focus, Sweet Dream, Deep Tissue.
Health Care - Sensei, Lymphatic Detox, Spine Care, Joint Care, Yoga Strength
LifeStyle - Sport Recovery, Relaxation, Rest & Reflex, Centripetal, Centrifugal

[Advance]	For manual massage selection
[Custom]	Selection for specific massage
[Air pressure Massage]	Auto air pressure massage for whole body or any other part
[Seat Adjustment]	Chair angle adjustment

2. Setting

User can do own refer setting for language, brightness, voice volume and sleeping mode. After done, please touch [X] to return back to main menu.



3. Child Safety Lock Screen

The child safety lock screen has been added as a safety precaution. After activating, the child safety lock screen will appear. User are require to hold down the [Pause] button for 5 second to unlock.

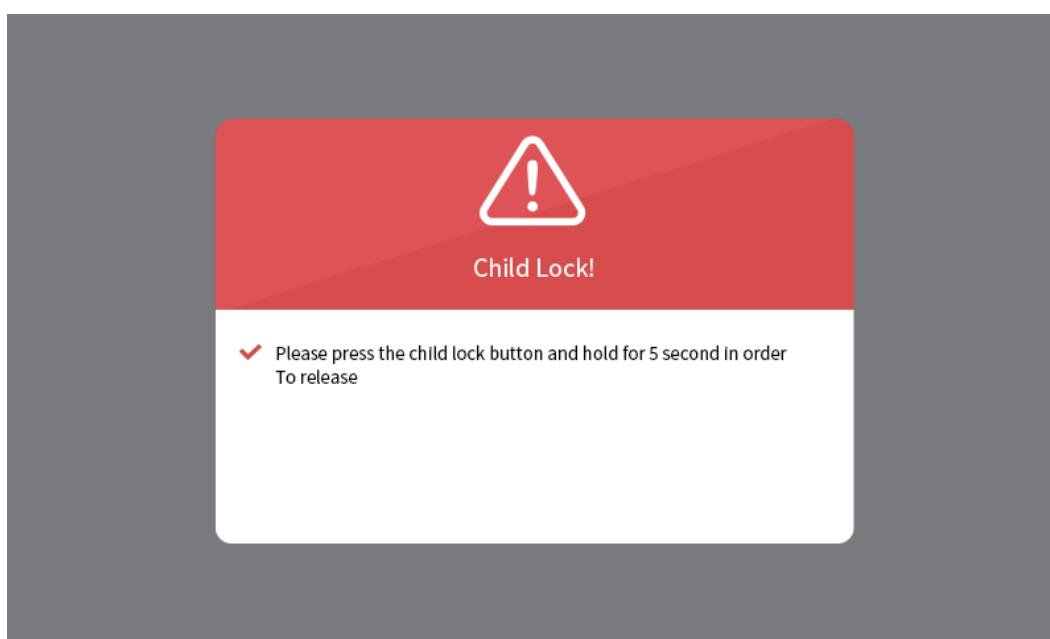

4. Pinch Point Prevention Screen

The pinch point prevention screen appear as another safety measure just before the device is turned off / chair detect foreign object. Check for any object that may prevent the chair from moving back to its original position. Then press [OK] to completely turn off the device

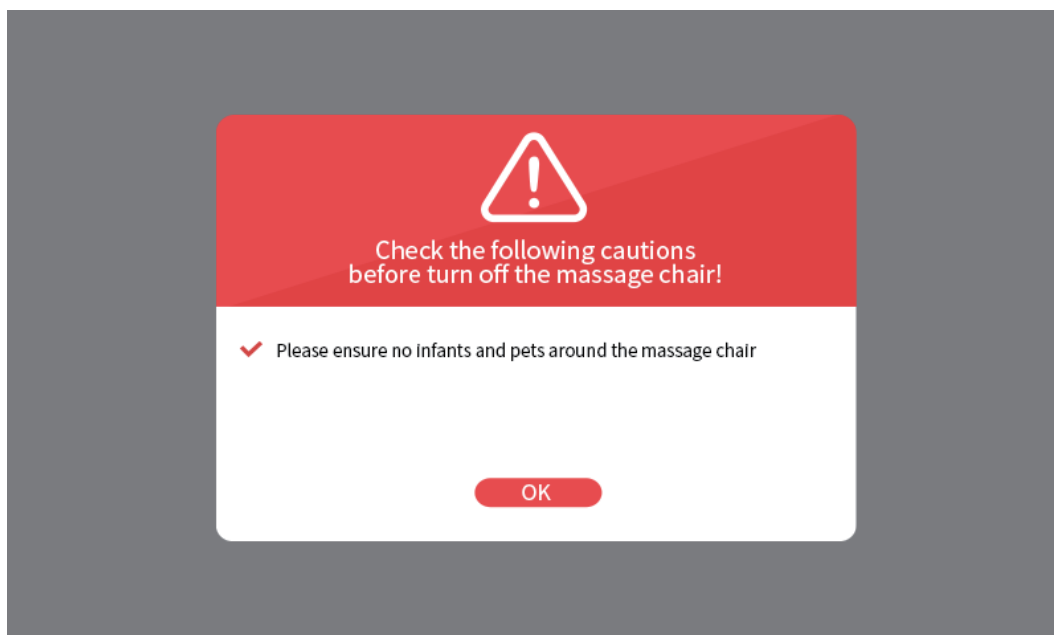
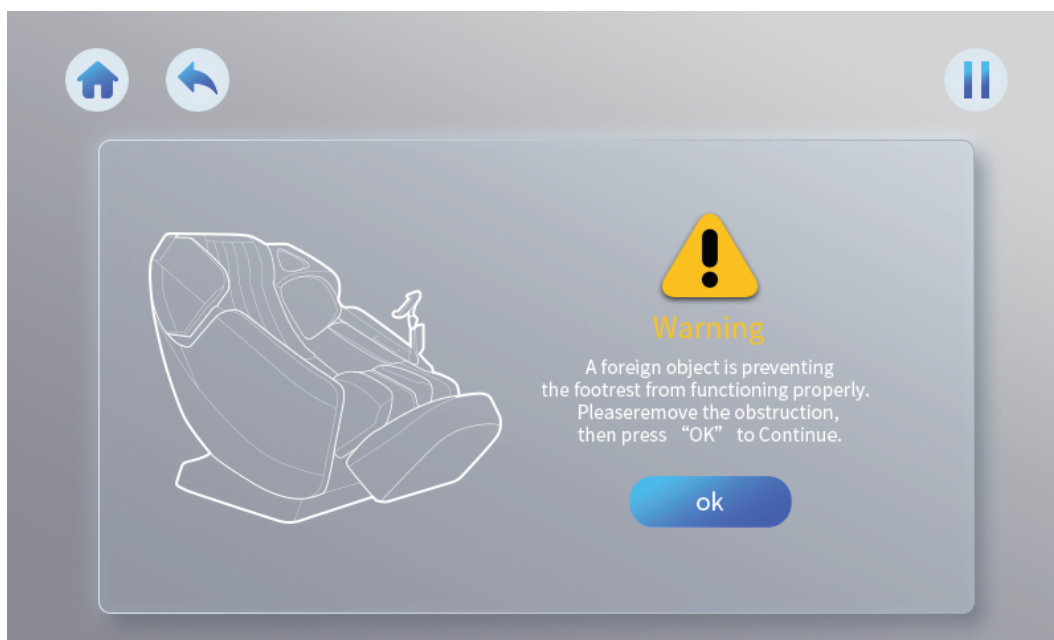

5. Body Shape Scanning

After activated any auto program or manual massage, before massage start, it will first go through the body shape scanning

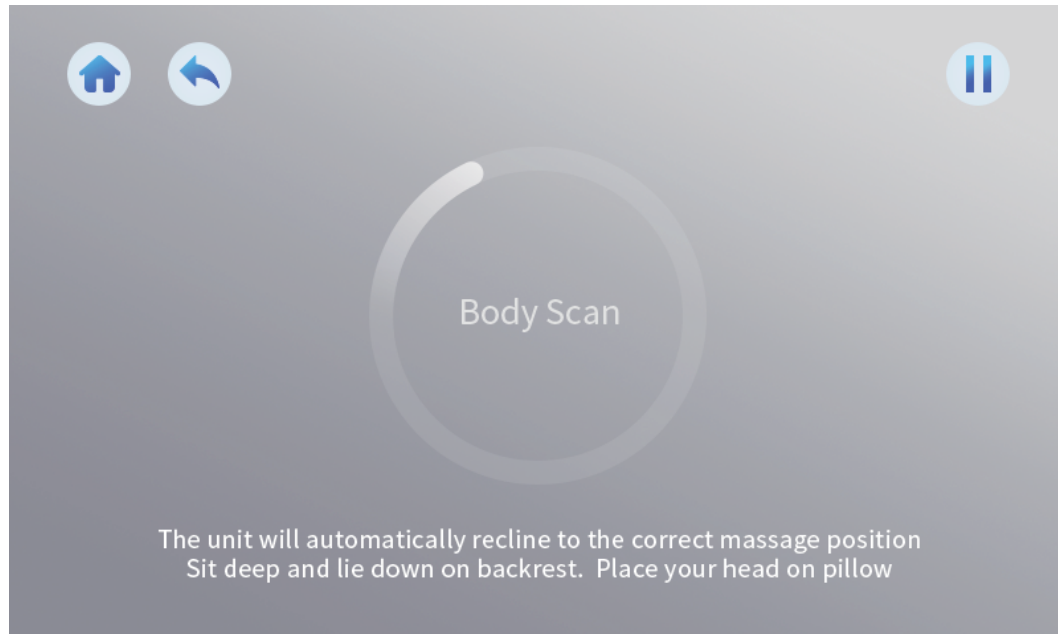

6. Shoulder Height Detection

This page will turn out after body scanning complete. User allow to do fine tune for the shoulder location if require

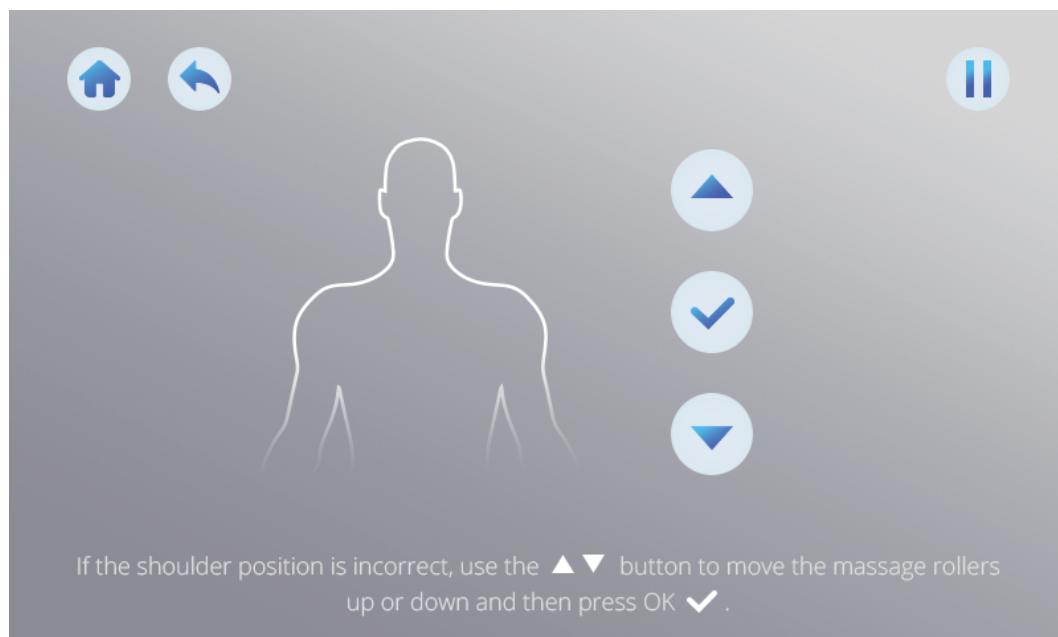

7. Body Scanning Error

During scanning, if machine detect error due to sitting posture or without user, this window will pop out. Please readjust the posture then press [scan] to perform another body scanning.

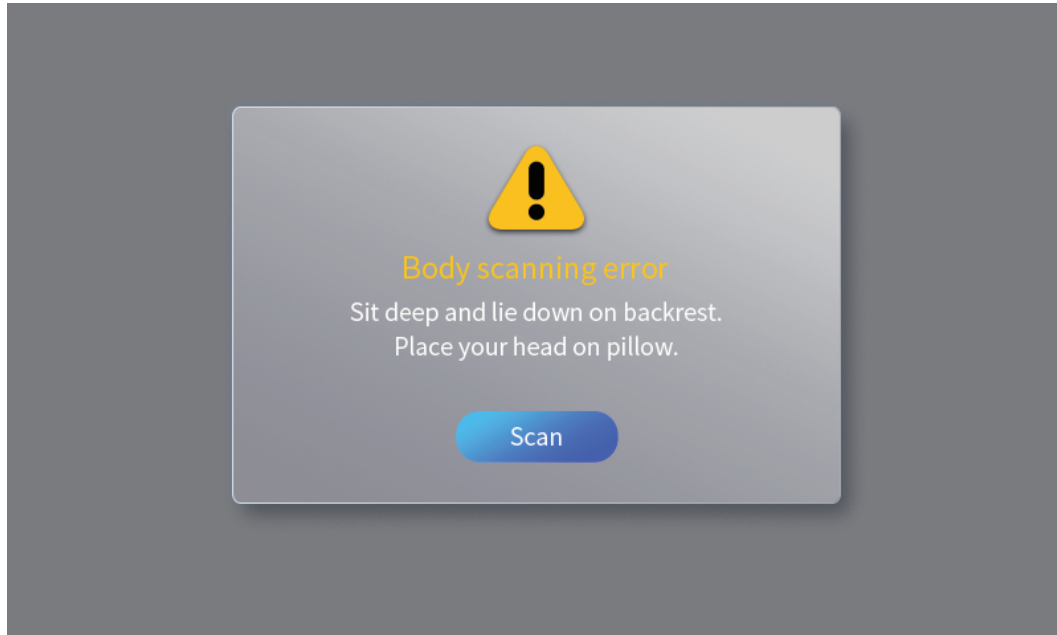

8. AI Body Fatigue Scanning

The body muscle fatigue scanning will appear when user activated AI Fatigue Tracker. The massage roller will move up and down to collect muscle hardness data then recommend suitable massage program.

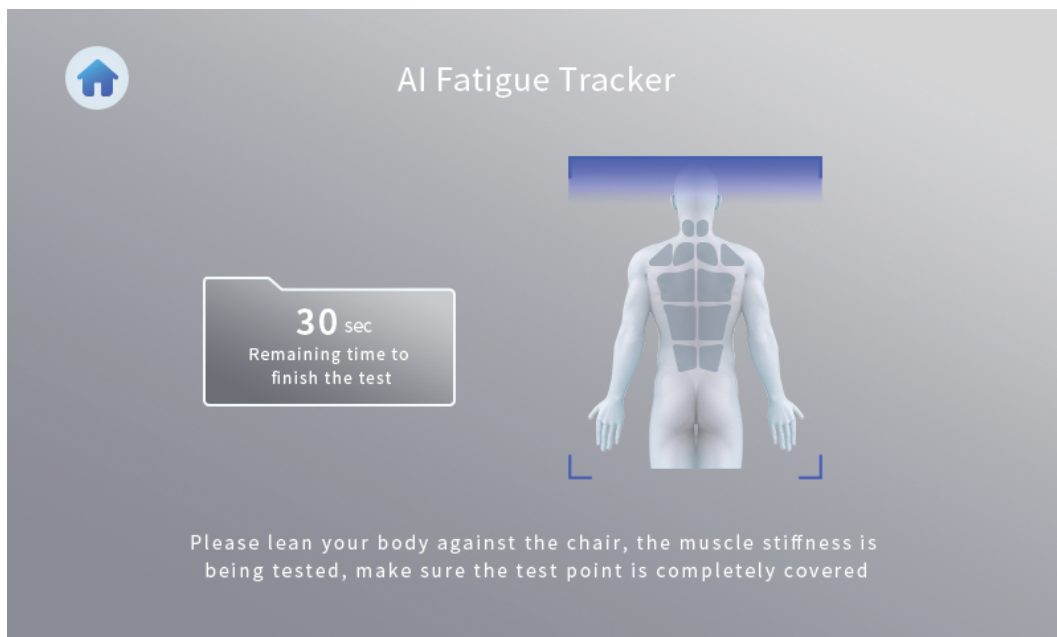

9. Auto Massage

The massage program will start after scanning complete and the above page will appear



[Home]	Main page
[Return]	Return back to previous page
[Voice command]	Voice command ON/OFF icon
[Internal music]	Internal music ON/OFF icon
[LED]	LED page entry
[Pause]	Emergency / temporary stop, touch again to resume back the activity
[4D]	Current 4D level
[Strength]	Current Strength level for tapping
[Intensity]	Current air pressure level
[Speed]	Current speed level for kneading
[Heat]	Massage roller and knee heating status
[Calf Massage]	Current calf massage status
[Foot roller]	Current foot roller status

* The function above can be adjust by touching the icon

10. Advance Message

The massage program will start after scanning complete and the above page will appear



- | | |
|--------------------|--|
| [4D] | Touch icon to increase 4D level |
| [Strength] | Touch icon for optional level selection from level 1 to 5 |
| [Intensity] | Touch icon for optional level selection from level 1 to 5 |
| [Speed] | Touch icon for optional level selection from level 1 to 5 |
| [Heat] | Window for roller heater and knee heater |
| [Massage location] | Window for massage location control such as Spot, Partial, Width, moving upward and downward |
| [Skill] | Window for massage skill selection such as Kneading, Tapping, Rolling, Shiatsu, clapping and swedish |

11. Custom

Create your own massage program. Tick the part of body you wish to massage. Combination is allowable.

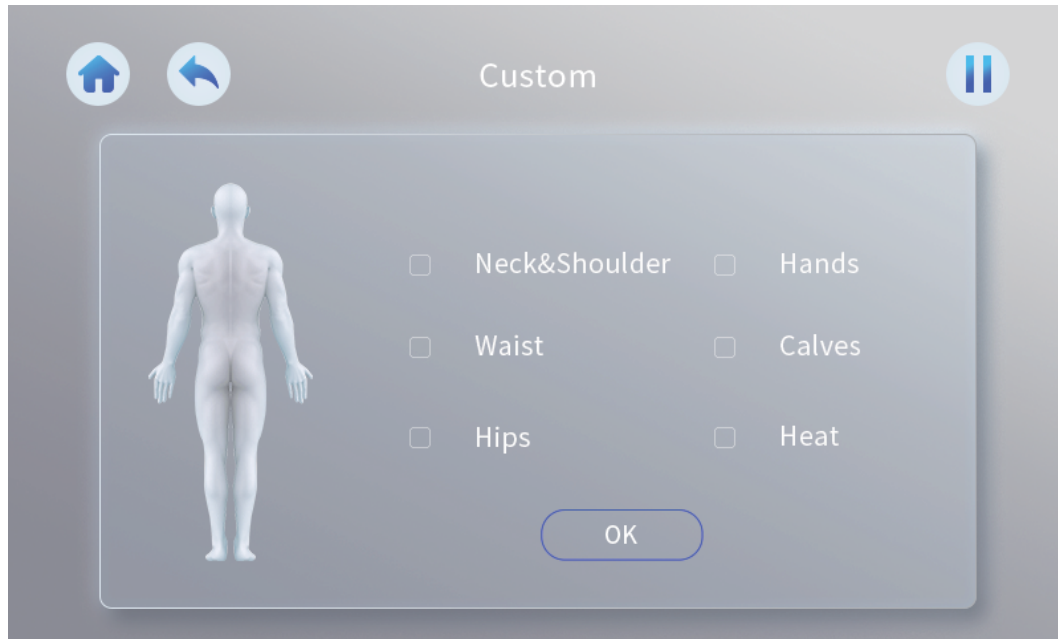

12. Air Pressure Massage

By touch the icon on screen to select area you need for air pressure massage, intensity, foot roller and calf massage



13. Seat Adjustment

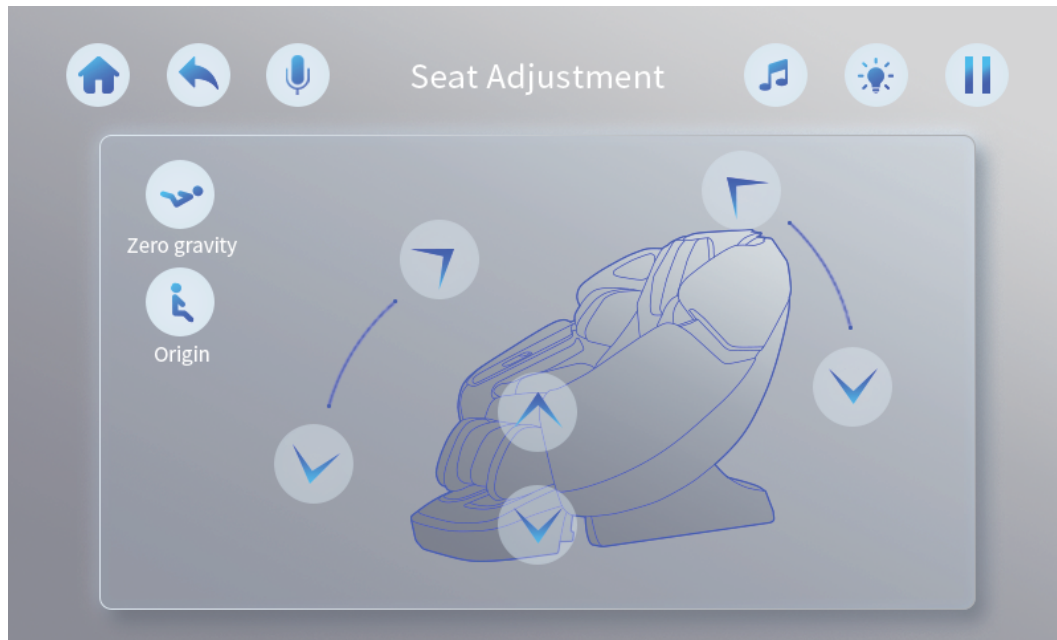

- | | |
|----------------|-------------------------------|
| [Zero Gravity] | Zero gravity angle adjustment |
| [Origin] | Back to original position |
| [Chair] | Restore / Recline |
| [Backrest] | Backrest inline / recline |
| [footrest] | Incline / recline |

14. LED

By touch the LED icon on the top left corner, the LED page as above will appear. Touch to select any color, touch again to turn off.

Negative ion ON/OFF also can select from here

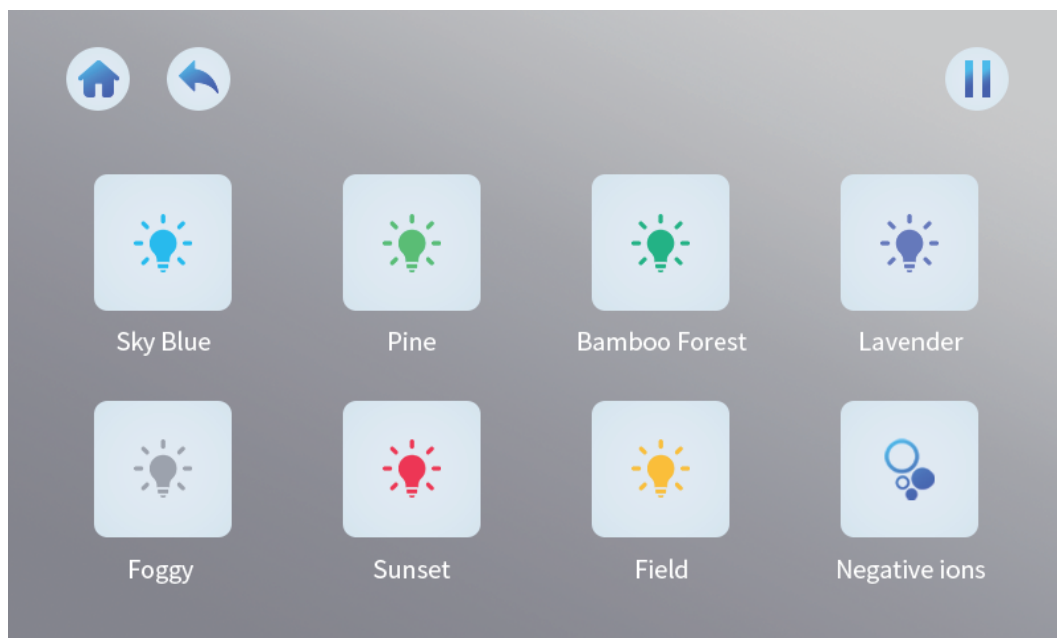

After massage

- 1** Make the foot massage section slide back to its original position.

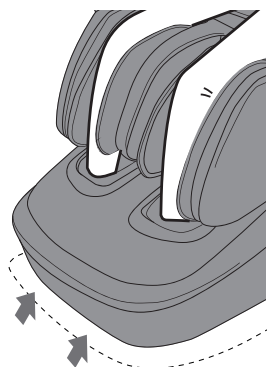

- 2** Move the feet from the Lower Leg/Foot massage section.

For safety, the footrest must be retracted after use.

Retracting method of the Lower Leg/Foot massage section

- Make sure there are no articles in the retracting position.

Slowly move the feet from the Lower Leg/Foot massage section.

Touch the footrest retract icon to allow the footrest back to origin position.

- 3** Insert the remote controller back into the remote controller holder.

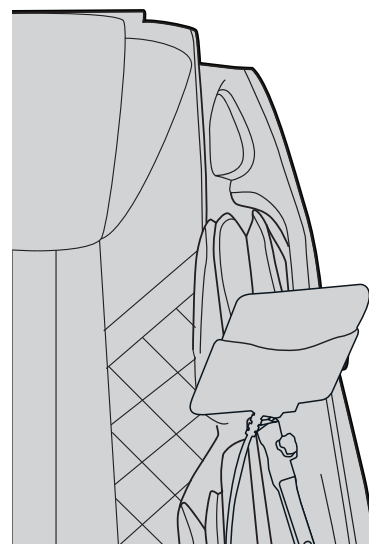

Warning

- Keep children or pet from using the product, playing on its main body, or climbing onto its Lower Leg/Foot massage section, seat surface, backrest or armrests; otherwise accidents or injuries may happen.

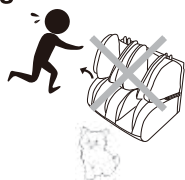

4 Power off the product.

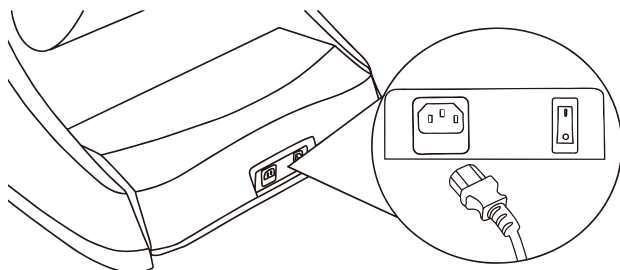

- ① Turn off the power switch.
- ② Pull out the power plug.

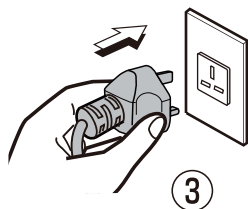

Warning

- After use each time, pull the power switch to the **O** position and pull out the power plug; otherwise accidents and injuries by playing with them by children may happen.

Timer function

Massage will end automatically when time is up.

- The Lower Leg/Foot massage section will descend automatically.
- The massage wheels will move to the retracting positions.
- The backrest will not raise automatically. If touch pad was shut off, press ON/OFF button, the backrest and footrest will rise up.

To stop the massage in halfway

Press

- The Lower Leg/Foot massage section will descend automatically and the massage wheels will back to the retracting positions.
- After the massage wheels are retracted, the backrest will raise.

If abnormal feeling

Press

- All the movements will stop immediately.
- Step down the product carefully to avoid turnover of the product.

If the pause button flashes

Press

- The massage chair immediate stop when the calf anti-pinch sensor was trigger and the PAUSE button will flash. After remove the obstacle, press the pause button to cancel the anti-pinch trigger, and then select the massage program again.

Cleaning and maintenance

Cleaning of the synthetic leather

Wipe the synthetic leather with a soft dry cloth.

- **Do not clean the product with chemicals such as thinners, gasoline and alcohol.**
- **When using a leather maintenance product (cleaning cloth) sold on the market, follow its directions for use.**
- **If the synthetic leather is very dirty, wipe it with the method below.**
 - ① Put a piece of soft cloth into water or 3% to 5% neutral detergent contained hot water and wring it out.
 - ② Wipe surface of the synthetic leather with the soft cloth.
 - ③ Wipe the detergent with a piece of cloth once soaked in clean water and wrung out.
 - ④ Wipe with a piece of wrung soft cloth.
 - ⑤ Have the synthetic leather take natural air drying.
- **If it is difficult to remove the stains on the synthetic leather, soak a piece of melamine foam bought from the market into a neutral detergent and use it wipe the product.**
- **Do not dry the surface by a hair drier.**
- **Surface of the synthetic leather may be dyed by fabric colors; therefore, be careful when wiping the product with denim or colored cloth.**
- **Keep these positions from long-time contact with plastics to avoid fading.**
- **Synthetic leather may discolor, so the position in contact with the hair dye used should be covered by a towel.**



water



mild detergent

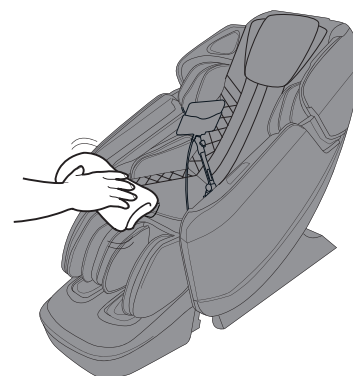

Cleaning of the plastic parts

1 Put a piece of soft cloth into water or neutral detergent contained hot water, wring it out and wipe the plastic parts.

- **Do not clean the product with chemicals such as thinners, gasoline and alcohol.**

2 Wipe with a piece of cloth once soaked in clean water and wrung out.

- **Wring the cloth out before using it to wipe the remote controller.**

3 Have the plastic parts take natural air drying.

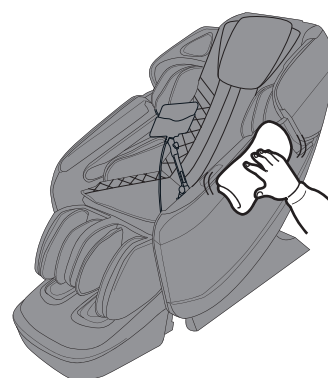

mild detergent



water



Questions and answers (Q&A)

Q Can persons paying frequent visits to hospitals because of diseases use the product?

A These persons should consult physicians before using the product. Massage is the so-called “touch-pressure stimulation”: Muscles are compressed to relieve their tension and promote hemokinesis. Some diseases may get worsened because of massage. Thus, consult the attending doctors before using the product.

Q How about the body height requirement for use of the product?

A The body height requirement differs with the specific body type. See the rough reference below when using the product. If a person shorter than 145 centimeters or taller than 185 centimeters uses the upper body massage function and the Lower Leg/Foot massage function of the product at the same time, it will be possible that his soles will have poor contact with the foot massage section or that his knees will need to be bent.

For a taller person with knee bending when using the product:

Select method **A** or **B** below:

- A** Tilt the backrest and lower the Lower Leg/Foot massage section; or
- B** Massage the upper body only with the help of the footrest.
(Massage the feet and the upper body separately.)

For a short person difficult to touch the foot massage section:

Select method **A** or **B** below:

- A** Raise the backrest and lift the Lower Leg/Foot massage section.
- B** Massage the upper body only with the help of the footrest.
(Massage the feet and the upper body separately.)

Q Are there any things needing special attention during moving?

A Pay attention to the following things during moving.

For convenience during moving, tilt backrest of the product till the lowest position.

During handling, do not sit on the product.

- ① Press ON button power on the product.
- ② Press  to make the backrest completely tilt.

Press the button until backrest and footrest stop



- ③ Turn off the power switch and pull out the power plug.
- If the original packing box is unavailable, make sure the power line is not wound on the product, wind it and place it on the seat surface. When handling the product, keep the power line from falling off and rubbing with ground.
- If the original packing box is unavailable, properly keep other packing auxiliary materials and wrap the product with them to avoid scratch and vibration during handling.

Q Where is serial number of the product?

A It is on back of the main body.

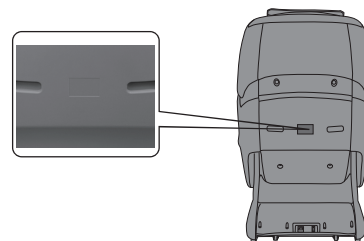

Q What should I do if I do not feel warm in the knee?

A [Knee Warm] Only fabrics in the tiptoe positions are warm. Make the tiptoes in close contact with the warm transfer part. When the knee massage section is being raised, the warm transfer part is in close contact with the knee make you feel warm. You may cover your knees with a blanket to get warmer.

Q I care about the sounds the product makes when being used.

A It is caused by the core structure.

Q Does it matter if the massage wheels have different massage intensities?

A This phenomenon possibly exists during massage because of the core structure. To simulate the most natural massage effect, the product is designed with a core structure allowing alternate back massage by a left massage wheel and a right massage wheel. During massage, the massage wheels possibly have slightly different positions on the back. That's why you have that feeling. It is not a fault.

Q The acupressure force is too large.

A Set the air bag intensity to be “1” through the Air Bag button. You can also lower the Lower Leg/Foot massage section to reduce the acupressure force on the feet.

Q How about monthly power consumption of the product?

A Supposing you massage for 30 minutes in two times (15 minutes for each time) on each day, about 2.5 kilowatt-hours will be consumed each month.

Troubleshooting

After a fault happens, inspect and try the corresponding method below.

If the fault still exists after that, contact the shop from which you bought the product.

Fault	Cause and elimination method
<p>The massage wheels stop during use (The product beeps and all icons and buttons on the remote controller flicker and then go out.)</p>	<p><u>For safety, the massage wheels will possibly stop upon a too large external force during use.</u> If all marks and buttons on the remote controller begin to flicker, it suggests an extreme abnormality. In this case, turn off the power switch and turn it on about 10 seconds later. If the massage wheels stop again, adjust your sitting posture and do not lean on the backrest completely. (Users, particularly those heavier than 100 kilograms, should follow relevant precautions.)</p>
<p>The product cannot tilt, or the footrest cannot be raised or lowered (The product beeps, the running light on the remote controller go out and the product stops)</p>	<p><u>For safety, the product will stop upon an obstruction or a too large force.</u> If all contents and buttons are flickering and the backrest or the footrest has stopped, turn off the power supply and turn it on about 10 seconds later and then operate the product.</p>
<p>The massage wheels cannot reach the shoulders or the neck</p>	<p>If the head is not in contact with the headrest, or the back is not in contact with the backrest, the shoulder position in body type detection will possibly be lower than the actual position. Sit in the deepest position of the product, lean your head on the headrest and operate from the beginning again.</p>
<p>The left and right massage wheels have different heights (intensities)</p>	<p>It is not a fault but a normal phenomenon because the product is provided with a massage core allowing alternate beats of the massage wheels.</p>
<p>The product cannot run at all. ● Upper body (the neck to the waist) massage ● Lower leg/foot massage</p>	<ul style="list-style-type: none"> ● The power line is disconnected. ● The power switch is not turned on. ● No program is selected after ON button on the remote controller is pressed.
<p>Neither the massage wheels nor the knee massage section provides a warm feeling</p>	<ul style="list-style-type: none"> ● The Back and knee heating button is set to be OFF. ● [Knee Warm] Only fabrics in the tiptoe positions are warm. The warm feeling depends on factors such as body type, massage method, clothes and room temperature. When the knee massage section is being raised, the warm transfer part is in close contact with the knee make you feel warm. You may cover your knees with a blanket to get warmer.
<p>The product cannot cool down even if the Dual-temperature function is disabled</p>	<ul style="list-style-type: none"> ● Due to the heater structure, the product will still feel warm shortly after heating because of the residual heat. ● If a single part is continually massaged even after the heating function is disabled, you will feel increasingly warmer.
<p>The heater does not heat even if the Back and knee heating is enabled function</p>	<ul style="list-style-type: none"> ● If neither upper body massage nor knee massage is enabled, the heating function will not work separately.
<p>The product is damaged</p>	
<p>The power line or the power plug has abnormal heating</p>	<p>To avoid accidents, contact an authorized service center.</p>

If above solution are not applicable, kindly refer to OGAWA service Center 1-800-88-4688.

Troubleshooting (Continued)

The sounds and feelings you care about in use of the product

You will hear or have the following sounds or feelings when using the product. It is not abnormal phenomena but results of the product structure.

- Sound when the stretching massages are retracted
- Sound and feeling when the massage wheels rub patterns on the fabric
- Sound of movements such as kneading and beat
- Friction sound of the running massage wheels
- Sound of up-down movement
- Sound of the conveyor belt
- Motor sound
- Sound of the squeezing massage wheels when they begin to stretch
- Sound when a person is sitting on the seat
- Friction sound between the armrests and the back cushion when the backrest is tilting
- Friction sound between the massage wheels and the fabric
- Sound of the inflator pump during Air Bag massage
- Sound of air exhaust during Air Bag massage
- Running sound of the solenoid valve at bottom of the product during Air Bag massage.
- Swing of the footrest
- Sound when the shoulders are stretched or moved
- Running sound of the air bags
- Sliding sound of the foot massage section
- Friction sound between the back cushion and the back cover leather when the backrest is tilting

If the sound is loud, it is also possible that the product has failed.

- In this case, have the product inspected and repaired by an authorized service center.

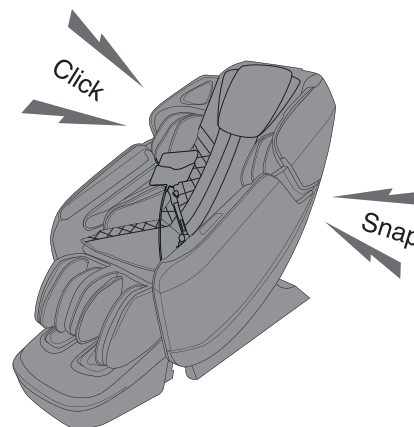

Warning

- **Do not refit, disassemble or repair the product without permission.** Otherwise fires, abnormal movements or personal injuries may happen.

Warning

- **In the case of any abnormality or fault, stop the product immediately and pull out the power plug to avoid fuming, fires and electric shocks.**
 - < Abnormality and fault examples >
 - The product fails to work after the power switch is turned to the ON position;
 - After the power line is moved, the product is discontinuously powered on;
 - In use, the product gives off a burning smell or an abnormal sound;
 - The product is deformed or abnormally heating
 - In any of these abnormalities and faults, have the product inspected and repaired by an authorized service center immediately.

Specifications

Product No.		OG7599
Product name		MAESTRO
Power supply		AC 220-240V~, 50-60Hz
Power consumption		150W
Upper body massage	Range of massage (up-down direction)	Approx. 1.35 m
	Range of massage (left-right direction)	Massage wheel spacing (including massage wheel width) during use of the product Massage wheel spacing (including massage wheel width) during rolling on the back and up-down moving: Approx. 4.5cm~18.5cm
	Range of massage (front-back direction)	Quantity of protruding massage wheels (adjustable intensity): Approx. 9.5cm
	Massage speed	Kneading: Approx. 19 times/min. ~ approx. 36 times/min. Beat: Approx. 267 times/min. ~ approx. 438 times/min. (single side) Moving speed: Approx. 2.5 cm/s ~ approx. 3.5 cm/s
Angle of inclination		Backrest: Approx. 128° ~ 154° Footrest: Approx. 7.8° ~ 66.5°
Automatic power-off		Approx. 15 minutes (automatic power-off)
Dimensions	When it is not tilting: (H×W×L)	Approx. 161cm x 78cm x 122cm
	When it is tilting: (H×W×L)	Approx. 203cm x 78cm x 116cm
Backrest	N.W.(kg): 92.6kg G.W.(kg): 111.5kg	MEAS.(L*W*H cm):134 x 83.5 x 126.5cm
Footrest	N.W.(kg): 23.4kg G.W.(kg): 26.5kg	MEAS.(L*W*H cm):57 x 55 x 57.5cm
Weight		Approx. 116kg
Maximum body weight of user		Approx.:100kg

For a user heavier than 100 kilograms, the product may have bigger noise and its fabric housing may be worn quicker.

Customer Support Guidelines

Warranty Guidelines

Massage chair interior parts
Mainboard, board parts, motors, air pump
Interior wiring/airhose

Fees Applied

Cover Sheet
Any fading or deterioration of fabric, product parts, exterior cover sheet, etc caused by personal use

Controller
Broken screens, damaged controller, etc. caused by personal use

*Operational noise do not imply malfunctioning product.

Fees Applied

Fees apply for the following.

- 01 Problems due to liquids spilled within interior of product.
 - 02 Broken or disabled parts due to excessive pressure.
 - 03 Problems due to deformation or external defects caused by personal actions.
 - 04 Problems due to not using part or cords provided by OGAWA.
 - 05 Problems due to incorrect use of product.
 - 06 Problems caused by user disabling parts of the machine.
 - 07 Problems caused by repairs conducted by non-OGAWA technician.
 - 08 Problems caused by natural disasters.
 - 09 Failure to follow safety precautions addressed in User Manual.
 - 10 Problems caused by personal misuse.
 - 11 Problems caused by user's reckless behaviour, inability to follow guidelines, and etc.
-

*If after evaluation result conclude problems are not user's fault, warranty will be issued.

Contact Us



MALAYSIA
Healthy World Lifestyle Sdn Bhd
No. 22 Jalan Anggerik Mokara 31/47
Kota Kemuning, 40460 Shah Alam
Selangor Darul Ehsan, Malaysia
Tel : +603-5121 4286
Fax: +603-5121 4386



HONG KONG, CHINA
OGAWA Health Care International (HK) Ltd
31/F,YHC Tower,1Sheung Yuet Road
Kowloon Bay
Kowloon
Hong Kong
Tel:+852 3465 6262
Fax:+852 2410 0119



SINGAPORE
OGAWA Health-Care Pte Ltd
27 Tampines Industrial Avenue 5,
T5 @ Tampines
Singapore 528623

Tel:+065-6846 8588
Fax:+065-6846 7677



VIETNAM
OGAWA Vietnam Co Ltd
2nd floor,Petroland Tower,
12 Tan Trao,Tan Phu ward
District 7
Ho Chi Minh
Tel:+84 8 3775 3093/3775 3094
Fax:+84 8 3775 3095



PHILIPPINES
O-Healthcare Solution Phil. Inc.
2303, 4th Floor, G&A Building,
Chino Roces Avenue Extension,
Makati City, Philippines
Tel : +632 889 0676 / + 632 844 6851
Fax: +632 812 0421

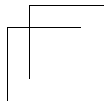
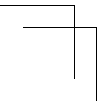
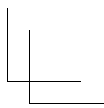
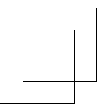

MAESTRO

POWERED BY OVERSEER

User Manual
All information is correct at the time of print

目录

使用前

- 重要的安全事项 SC 1
- 接地说明 SC5
- 产品结构 SC6
- 设置按摩椅 SC8
- 组装 SC9
- 使用前 SC10

使用方法

- 心灵理疗介绍 SC14
- 快捷操作 SC15
- 操作说明 SC16
- 按摩结束 SC25

维护

- 清洗及保养 SC27



Q&A/重要事项

- Q&A SC28
- 故障检修 SC29
- 规格 SC31
- 客户服务指南 SC32
- 联系我们 SC33



重要的安全事项 必须遵守



下文列举的是使用中为防止人身、财产损害而必须严格遵守的安全事项。

■ 所有安全事项将根据因错误使用而导致危害或损害的程度，予以说明。





 警告	可能造成重伤或死亡后果的事项内容。
 注意	可能造成轻伤或财产损害的事项内容。

■ 请注意各安全事项前的符号。（下文为符号范例）

 绝对禁止事项。	 必须执行事项。
--	--

 警告			
 必须遵守	<ul style="list-style-type: none"> ● 正在接受治疗或有以下症状的人，在使用本机前，应咨询医师。 <table style="width: 100%; border: none;"> <tr> <td style="width: 50%; vertical-align: top;"> <ul style="list-style-type: none"> (1) 佩戴起搏器或其他易受电子干扰的体内植入型电子医疗器械的人 (2) 恶性肿瘤病人 (3) 心脏病病人 (4) 被查证丧失辨别温度能力的人 (5) 孕妇或刚完成分娩的人 (6) 因糖尿病等高度末梢循环障碍引起知觉障碍的人 (7) 骨质疏松症患者、脊椎骨折病人、患有扭伤或肌肉拉伤等急性疼痛性疾病的人 </td> <td style="width: 50%; vertical-align: top;"> <ul style="list-style-type: none"> (8) 按摩部位受伤的人 (9) 体温 38℃ 以上(有发热症状)的人 (例：急性炎症症状[如倦怠感、寒颤、血压变动等]强烈时、身体虚弱时) (10) 必须静养或身体显著不适的人 (11) 脊椎异常或脊椎弯曲的人 (12) 患有椎间盘突出症的人 (13) 除上述之外，身体感觉特别不适的人 </td> </tr> </table> <p>否则恐发生事故或造成身体不适。</p> ● 使用中感到身体异常、或使用后觉得没有效果时，请立即停止使用，并咨询医师。 否则恐发生事故或造成身体不适。 ● 按摩中或移动靠背、小腿·脚部按摩部时，请事先确认本机周围（本机后面、下面、前面和侧面）没有人或宠物。 ● 使用前请务必确认靠背和后盖之间无异物或者宠物。 否则恐发生事故或造成身体不适。 ● 在使用本机前，一定要掀开靠垫，以检查靠背覆盖在按摩轮活动范围上的面料是否破损或者其他部位的面料是否破损。 (无论发现多么细小的破损，都请立即停止使用，拔掉电源插头，并将本机报修。) 在面料破损的情况下使用本机，可能引发受伤或触电的危险。 ● 开/关前请确保椅子周围没有物体。 ● 每次按摩请控制在 30 分钟内。 ● 请将对身体同一部位的按摩控制在 5 分钟内。 否则可能出现负面效果并造成伤害。 ● 每次使用完毕，应将电源开关滑到“O”（关闭）位置，拔掉电源插头。 否则可能因儿童顽皮引发事故或造成伤害。 ● 请严格遵守插座和配线器具的使用规定。 ● 请使用 220-240V~, 50/60Hz 交流电。 (请勿在国外使用本品，或擅自连接变压器。) 否则可能引发触电、机体故障或因过热导致火灾。 ● 请务必将电源插头插到底，使其确实地插入插座中。 否则可能引发触电或因过热导致火灾。 	<ul style="list-style-type: none"> (1) 佩戴起搏器或其他易受电子干扰的体内植入型电子医疗器械的人 (2) 恶性肿瘤病人 (3) 心脏病病人 (4) 被查证丧失辨别温度能力的人 (5) 孕妇或刚完成分娩的人 (6) 因糖尿病等高度末梢循环障碍引起知觉障碍的人 (7) 骨质疏松症患者、脊椎骨折病人、患有扭伤或肌肉拉伤等急性疼痛性疾病的人 	<ul style="list-style-type: none"> (8) 按摩部位受伤的人 (9) 体温 38℃ 以上(有发热症状)的人 (例：急性炎症症状[如倦怠感、寒颤、血压变动等]强烈时、身体虚弱时) (10) 必须静养或身体显著不适的人 (11) 脊椎异常或脊椎弯曲的人 (12) 患有椎间盘突出症的人 (13) 除上述之外，身体感觉特别不适的人
<ul style="list-style-type: none"> (1) 佩戴起搏器或其他易受电子干扰的体内植入型电子医疗器械的人 (2) 恶性肿瘤病人 (3) 心脏病病人 (4) 被查证丧失辨别温度能力的人 (5) 孕妇或刚完成分娩的人 (6) 因糖尿病等高度末梢循环障碍引起知觉障碍的人 (7) 骨质疏松症患者、脊椎骨折病人、患有扭伤或肌肉拉伤等急性疼痛性疾病的人 	<ul style="list-style-type: none"> (8) 按摩部位受伤的人 (9) 体温 38℃ 以上(有发热症状)的人 (例：急性炎症症状[如倦怠感、寒颤、血压变动等]强烈时、身体虚弱时) (10) 必须静养或身体显著不适的人 (11) 脊椎异常或脊椎弯曲的人 (12) 患有椎间盘突出症的人 (13) 除上述之外，身体感觉特别不适的人 		

警告

 必须遵守	<ul style="list-style-type: none"> ● 请定期清理电源插头上的灰尘等脏污。 否则可能因湿气等原因引发绝缘不良，从而导致火灾。 （请用干燥的抹布擦拭电源插头。） ● 发生异常、故障时，立即停止使用，拔掉电源插头。（否则可能冒烟、起火、触电） <异常、故障事例> <ul style="list-style-type: none"> • 接通电源开关后可能不动作 • 移动电源线，有时通电有时不通电 • 运行中发出焦臭味、异常声响 • 按摩椅变形或者异常发热 → 请立即委托授权服务中心检查和修理。
 禁止	<ul style="list-style-type: none"> ● 请勿将靠垫伸入靠背和后盖之间。 否则可能会导致机体故障。 ● 请握住边框进行本机搬运。 否则可能会导致机体故障或人身伤害。 ● 下列人员请勿使用本机。 被医生禁止按摩的人（例：患有血栓症、重度动脉瘤、急性静脉瘤、各种皮肤炎或皮肤感染症〔包括患皮下组织炎症〕的人等） 否则可能会导致病情恶化。 ● 下列人员请勿使用腰部按摩。 <ul style="list-style-type: none"> • 患有急性腰痛、椎间盘突出症、腰椎移位症的人 • 罹患变形性髋关节症等髋关节不适的人 否则可能会导致病情恶化。 ● 在使用中请勿将手、手臂、脚塞入靠背覆盖在按摩轮活动范围上的面料。 ● 儿童禁止使用本机。此外，请勿让儿童在本机上玩耍，或者爬到小腿·脚部按摩部、座面、靠背或扶手上。 ● 请勿攀爬靠背或者扶手。 ● 请勿倚靠或坐在靠背上。 ● 请勿将头伸入靠背和后盖之间的活动区域。 ● 请勿让不能表达自己意思的人或没有能力操作本机的人使用本机。 ● 按摩颈部时，请注意按摩轮的动向，请勿按摩前颈，请避免过重地按摩颈部。 否则可能会引起事故或造成伤害。 ● 请勿损坏电源线及电源插头。 （请避免此类行为：损伤、加工、强行弯曲、扭转、拉长电源线及电源插头，或将电源线及电源插头靠近发热器，或在电源线及电源插头上系重物、或任意捆绑。） 使用破损的电源线或电源插头，可能引起触电、短路或引发火灾。请到购买本品的商店或指定的维修中心咨询修理电源线或电源插头的方法。 ● 使用“温热”按摩轮时，不要让按摩轮长时间接触同一位置。 ● 请勿长时间使用“膝盖温热”按摩。 可能出现低温烫伤*。 *即使温度相对较低（40℃～60℃），长时间接触皮肤的同一部位没有发热、疼痛等自觉症状，也可能导致低温烫伤。 ● 请勿损膝盖部温热（加热器）。 <ul style="list-style-type: none"> • 不要将别针、针扎进本机。 • 不要用刀具损伤。 损伤内部加热器可能导致火灾或者触电事故。
 湿手禁止	<ul style="list-style-type: none"> ● 请勿用沾湿的手插、拔电源插头。 否则可能导致触电事故。
 分解禁止	<ul style="list-style-type: none"> ● 请勿擅自改造本机。请勿自行分解或修理本机。 否则可能导致起火、异常动作、人身伤害。

⚠ 注意



必须遵守



- 下列人员即使目前身体健康，也请咨询医师后再使用本机。
(1) 因年龄增长而导致肌肉萎缩的人或身体纤瘦的人 (2) 因骨头或内脏问题而感觉腰痛的人
(3) 容易扭伤或容易瘀伤的人 (4) 晕车、晕船或乘坐其它交通工具时，反应异常激烈的人
(5) 过去曾被施予心脏手术或其它内脏手术的人
否则可能有损自身健康。
- 就坐前，请先确认本机各个部件之间没有异物。
(确认后盖、靠背、座面、小腿·脚部按摩部、靠垫内侧没有夹杂异物。)
否则可能因手、脚或其它物件被本机夹住，而引发事故、造成伤害或机体故障。
- 头部佩戴任何硬质饰物（如发卡等）时请勿使用本机。
● 当裤子口袋内部有硬物时（如手机、钥匙等），将其取出，然后按摩。
● 按摩手、手臂时，取下手表、指甲套、戒指等。
否则可能导致伤害。
- 就座前，确认按摩轮处在收纳位置。
● 按摩途中若想离开座位，必须先停止按摩椅运作，再离开座位。
否则可能引发事故或造成伤害。
- 请勿扯电源线试图拔出电源插头，一定要握住插头本身将其拔出。
否则可能引发触电或短路。
- 移动本机前，必须把小腿·脚部按摩部的角度调节回最初位置。
否则可能造成伤害。
- 如果使用滑轮移动本机，在地板上垫上垫子等。
否则可能在地板上留下伤痕。
- 请勿让儿童使用遥控器托架的固定螺丝。
否则可能因儿童误食或顽皮引发事故或造成伤害。
- 使用滑轮移动本机前，须先清空周围障碍物。抬起小腿·腿部按摩部座面到略低于腰的位置，慢慢移动。
否则可能因机身翻倒引发事故或造成伤害。
- 须将本机放置在水平面上使用。
否则可能因机身翻倒引发事故。
- 因使用本产品而产生出疹、红肿、发痒等症状时，请立即停止使用，并咨询医师。
否则可能引发事故或导致身体不适。
- 闲置一段时间后使用本品，请先重新阅读一遍产品使用说明书，并确认机体运作正常后，再开始使用。
否则可能引发事故或造成伤害。



禁止

- 请勿和其它器械同时使用。
否则可能造成事故或引起身体不适。
- 请勿将头部、腹部或皮肤紧贴按摩轮。此外，请勿将手或脚伸入按摩轮之间。
- 请勿将膝盖夹在小腿和脚部按摩部之间。
- 勿在使用本机时入睡。此外，饮酒后请勿使用本机。
- 当鼓起的座面气囊里的空气没有被排完时，不要站在座面上，或者跳上去，或者在上面放东西。
否则可能导致事故、伤害。

⚠ 注意

 禁止	<ul style="list-style-type: none"> ● 请勿将手或脚伸入本机与小腿·脚部按摩部之间。 ● 请勿将手·手臂或头伸入小腿·脚部按摩部（腿置台）的缝隙间。 安全起见，结束按摩后，请一定要收纳好小腿·脚部按摩部。 ● 请勿将手·手臂或头伸入靠背和后盖之间。 ● 请勿将宠物放在按摩椅上（后盖、靠背、扶手等）。 ● 按摩中，请勿突然拔出电源插头，或突然关闭电源开关。 否则可能造成伤害。
	<ul style="list-style-type: none"> ● 请勿站立或坐在后盖上。 否则可能导致本机翻倒，造成人身伤害。
	<ul style="list-style-type: none"> ● 请勿站立或坐在扶手上。 否则可能导致人身伤害。
	<ul style="list-style-type: none"> ● 请勿站立或坐在小腿·脚部按摩部及腿置台上。 否则腿置台前部旋转或者本机倾倒可能导致事故、伤害。 小腿·脚部按摩部底部撞到地板时，可能损坏地板。
	<ul style="list-style-type: none"> ● 请勿在已安装好的状态下拖动或推动本机。 否则可能损坏地板。
	<ul style="list-style-type: none"> ● 请勿在有人入座时移动本机。 否则可能因机身翻倒引发事故或造成伤害。
	<ul style="list-style-type: none"> ● 请勿在电热毯等加热设备上使用本机。 否则可能引起火灾。
	<ul style="list-style-type: none"> ● 请勿将遥控器放置在座面上。 否则可能损坏本机。 ● 不建议体重超过 100 公斤的人使用此设备 ● 请谨慎使用脑部按摩程序
 禁止湿手触碰	<ul style="list-style-type: none"> ● 请勿在浴室或其它潮湿的地方使用本机。 否则可能引发触电或机体故障。
 禁止沾湿	<ul style="list-style-type: none"> ● 请勿将水滴等物质撒在本机或遥控器上。 否则可能引发触电、短路或引起机体故障。
 拔出电源插头	<ul style="list-style-type: none"> ● 清洗及保养本机，必须先从插座上拔出电源插头。 否则可能引发触电或造成伤害。 ● 停电时立刻拔出电源插头。 否则可能在恢复供电时导致事故、伤害。 ● 不用时，一定要从插座上拔出电源插头。 否则灰尘、湿气可能导致绝缘老化，引发漏电火灾。

接地说明

- 本机必须接地。如果本机发生功能故障，可以使用接地来减少触电危险。
- 本机装备了具有设备接地导线和接地插头的电源线。必须将该插头插入已完全依照当地代码和法令进行正确安装和接地的、合适的插座。

注意

- 若设备接地导线的连接不当，则会导致触电危险。如果您对本机的接地是否正确存有疑问，请委托专业电工进行检查。即使本机附带的插头与插座不配，也不能对其进行改造。请委托专业电工安装合适的插座。
- 本机具有接地插头。请确认本机连接至具有与插头形状匹配的插座。
- 本机不能使用转接插座。
- 如果电源线损坏，必须使用专用的电源线或从其制造商或维修部买专用组件来更换。

注意:因产品质量改进，产品图片或内容描述可能会略有不同。

- 在没有得到监督和指导的情况下，本机器不适用于身体、感官、智能较弱，或缺乏使用经验和知识的群体(包括儿童)。
- 请勿让儿童在本机器上玩耍。
- 本机器有加热功能，对热度较不敏感的用户在使用本机器时需多加注意。

该用户手册也可以从网络下载，网址是：www.ogawa.com.cn

产品结构

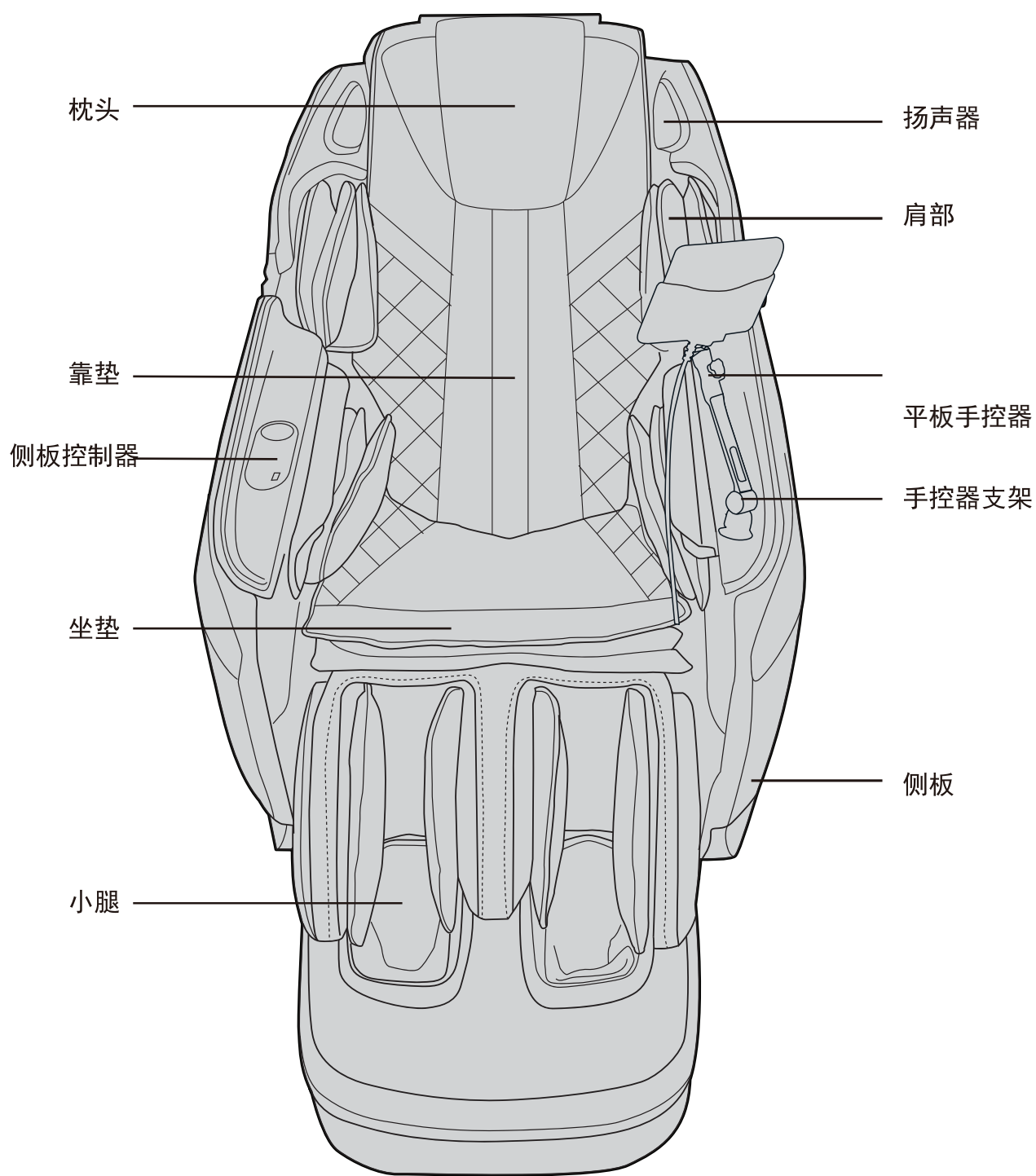

产品结构

气囊按摩位置

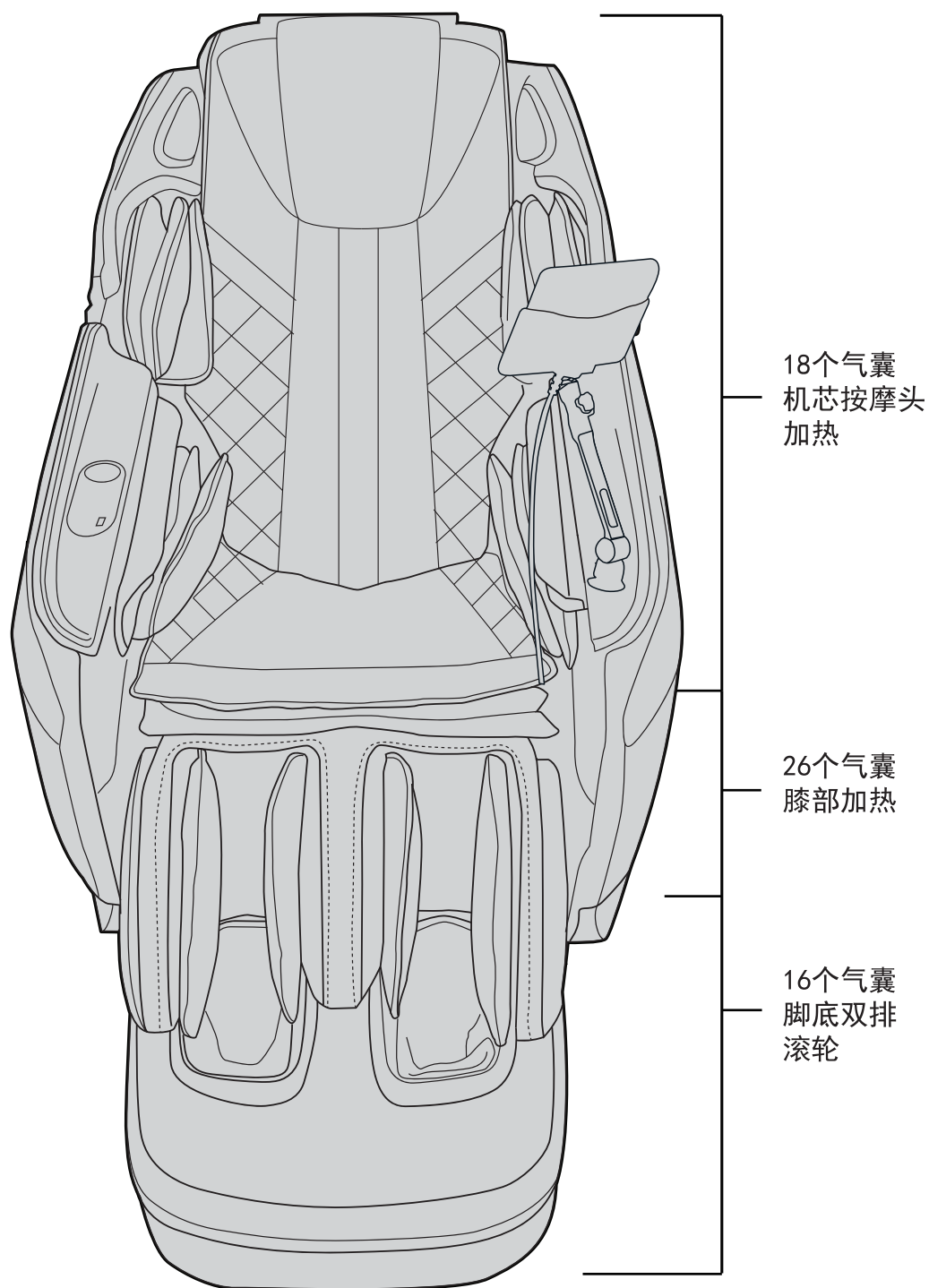

设置按摩椅

1 使用前(安装位置)

- 确保足够空间以便按摩椅可以倾斜。

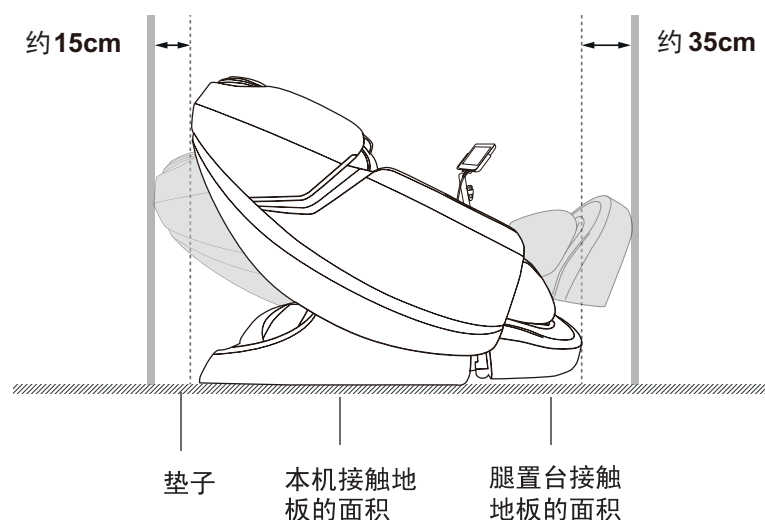

- 请勿将按摩椅暴露于阳光直射或高温环境下(如, 加热设备前), 因为这样可能导致按摩椅合成皮革褪色或硬化。
- 为避免地板损伤, 请在本机下铺上垫子。平铺垫子时, 垫子的大小应足以盖住本机接触地板的范围与腿置台接触地板的范围(至少 200cm X 90cm), 如图所示。
- 安装本机时应靠近电源插座。

2 产品移动说明

方法一: 拖住两边侧板, 然后抬起

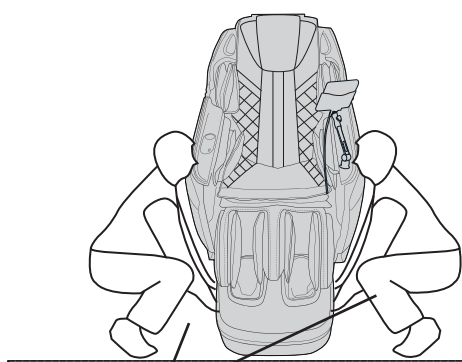

在木地板等易损的地面上
请抬起侧板进行移动。

※注意
不要将手置于下侧中部
凹槽内防止外侧版抠出。

- 由于本机较重, 因此搬运时请小心, 以免造成背部拉伤。(本机必须由两人或多人搬运。)

本机重量

约116kg

将本机放置在地板上

- 缓慢地放下本机, 小心脚部被压伤。
- 直到机身完全放平前, 请勿放开腿置台。突然松手, 将导致腿置台弹回最初位置。
- 地板可能受损, 因此, 建议在地板上铺上垫子等物品。

⚠ 注意

- 请勿在已安装好的状态下拖动或推动本机。
- 请勿握住窗口边框进行本体搬动。
否则可能会导致机体故障或人身伤害。
- 不要在地板上使用滑轮移动。
否则可能在地板上留下伤痕。
- 请勿在有人入座时移动本机。
否则可能因跌倒导致事故、伤害。
- 移动本机时，不要握持脚部按摩部分。
移动在滑动可能导致伤害。

方法二：使用滑块移动本机

⚠ 注意

以右图方式 推动按摩椅，但此方法不适用于木地板推动，否则可能在木地板上留下划痕。

- 1 按下开关键按钮。
- 2 将靠背和小腿返回至其原始位置。
将电源开关滑到"0" (关闭) 位置，拔下本机插头。

将遥控器和电源线放在座位上。



组装

(请翻阅产品安装说明)

使用前

1 检查周围

确定本机周围没有人、宠物及其它物体。

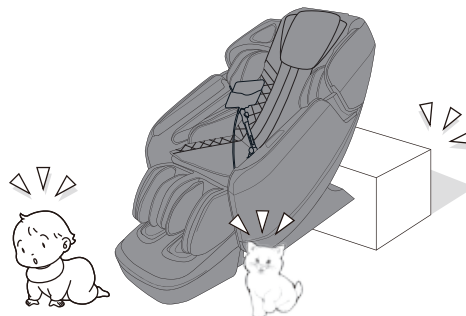

2 卷起靠垫并以拉链固定

卷起靠垫并以拉链固定在本体上。

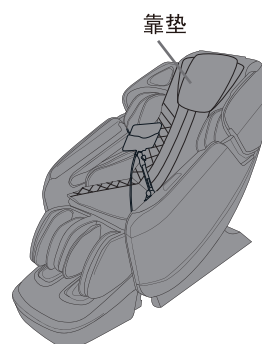

3 确保本机缝隙间没有异物。

小腿、脚部按摩前，确认没有夹住异物

⚠ 注意

- 不要将手、手指、脚、头伸进小腿与座面、扶手的间隙中间
- 就坐前，请先确认本机各个部件之间没有异物。
- 请勿将手、手臂或头伸入靠背与后盖之间。
- 请勿将宠物放在按摩椅上（后盖、靠背、扶手等）。

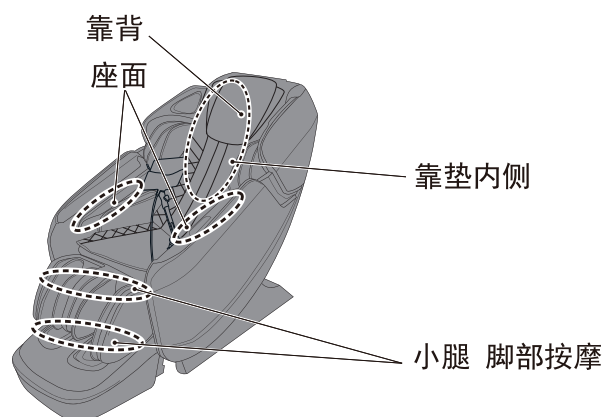

4 检查电源线及电源插头

警告

- 请定期清理电源插头上的灰尘等脏污。否则可能因湿气等原因引发绝缘不良，从而导致引发火灾。
(请用干燥的抹布擦拭电源插头。)
- 请勿损坏电源线及电源插头。
(请避免此类行为：损伤、加工、强行弯曲、扭转、拉长电源线及电源插头，或将电源线及电源插头靠近发热器，或在电源线及电源插头上系重物、或任意捆绑。)
使用破损的电源线或电源插头，可能引起触电、短路或引发火灾。请到购买本品的商店或指定的维修中心咨询修理电源线或电源插头的方法。

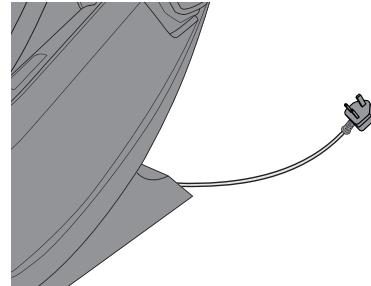

请注意，不要被电源线绊住脚部等。

务必将接口完全推入设备电源输入插口。

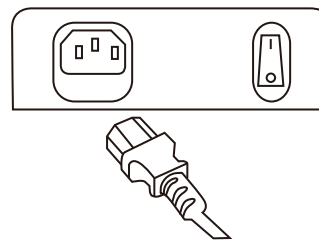

5 打开电源

- ① 将电源插头插入电源插座。
- ② 将电源开关滑到“**I**”（开启）的位置。

警告

- 请务必将电源插头插到底，使其确实地插入插座中。否则可能引发触电或因过热导致火灾。
- 请严格遵守插座和配线器具的使用规定。
● 请使用 220-240V~、50/60Hz 交流电。
(请勿在国外使用本品、或擅自连接变压器。)
否则可能引发触电、机体故障或因过热导致火灾。
- 请勿用沾湿的手插、拔电源插头。

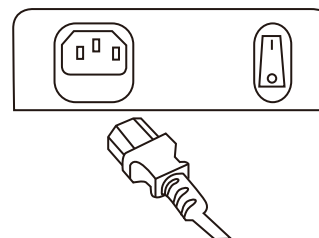
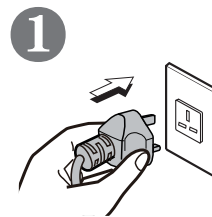

使用前 (续)

6 确认按摩轮处于收纳位置

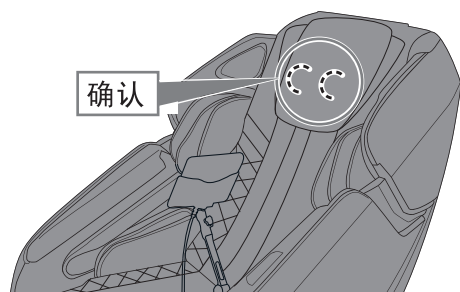

按摩轮不处于收纳位置时，
按下开机键返回收纳位置。

7 确认面料未破损或存在裂缝

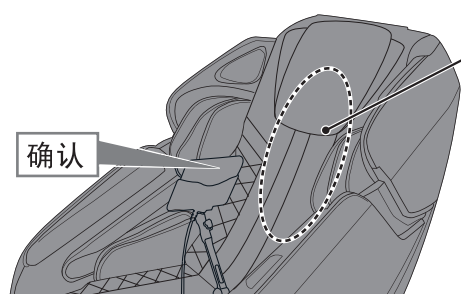

检查区域：
靠背覆盖在按摩轮活动范围上的面料

警告

- 在使用本机前，一定要掀开靠垫，以检查图示区域面料是否破损。其他部分也要确认面料是否破损。（无论发现多么细小的破损，都请立刻停止使用，拔掉电源插头，并将本机送修。）
在面料破损情况下使用本机，可能引发伤害或触电的危险。

8 根据需要调整椅子

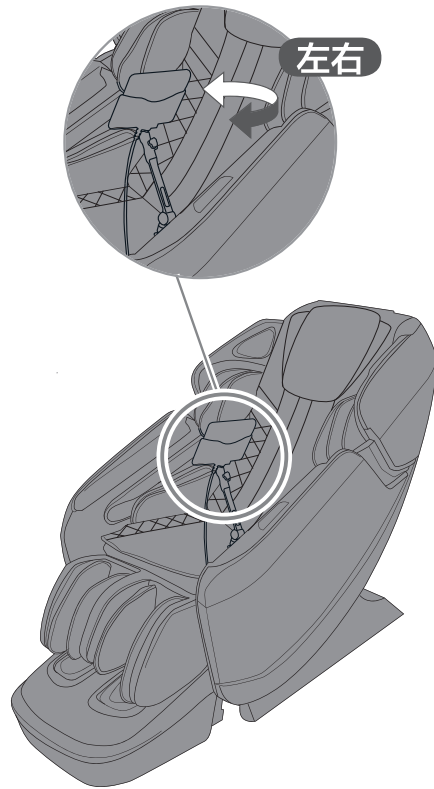

调节平板手控器

- 可调节左右方向。

9 根据需要调节脚部按摩部长度

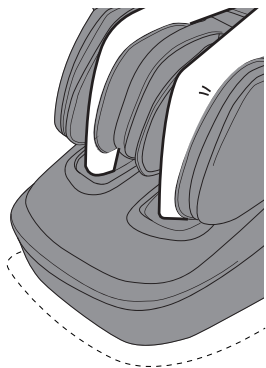

身材高大的人士

- 电动调节脚部按摩部长度，膝盖就不容易悬空。

当下小腿自动调整到舒服位置时，用脚跟踩下底部感应器以便停止调整。

心灵理疗介绍

MAESTRO

POWERED BY OVERSEER

双耳节拍让大脑休息 - 提高生产力

OGAWA独家按摩模式结合按摩和双耳节拍音乐来改善大脑活动。双耳节拍：当两种不同频率的声音进入耳朵时，大脑中会产生第三种声音。这第三个声音与脑电波一致，可以让您进入更深层次的放松状态并提高注意力。

波形	特征
δ	深度睡眠，疗愈
θ	深度放松，冥想
α	轻松专注、加速学习、减轻压力
β	集中注意力、分析思维和解决问题

大脑透过光疗法 - 改善睡眠质量

OGAWA独家按摩模式与红灯结合。红光波长刺激褪黑激素的产生。褪黑激素是一种天然存在的激素，可以帮助您入睡。当黑暗降临时，你的大脑会释放更多的褪黑激素，而当你暴露在光线下时，释放的褪黑激素往往会减少。

大脑+负离子 - 缓解压力

OGAWA独家按摩模式与负离子相结合。想想山脉、瀑布和海滩。一旦它们到达我们的血液，负离子被认为会产生生化反应，增加情绪化学血清素的水平，有助于缓解抑郁、缓解压力，让我们整天充满能量。

快捷操作

右侧板设置快捷按键，具体功能描述如下

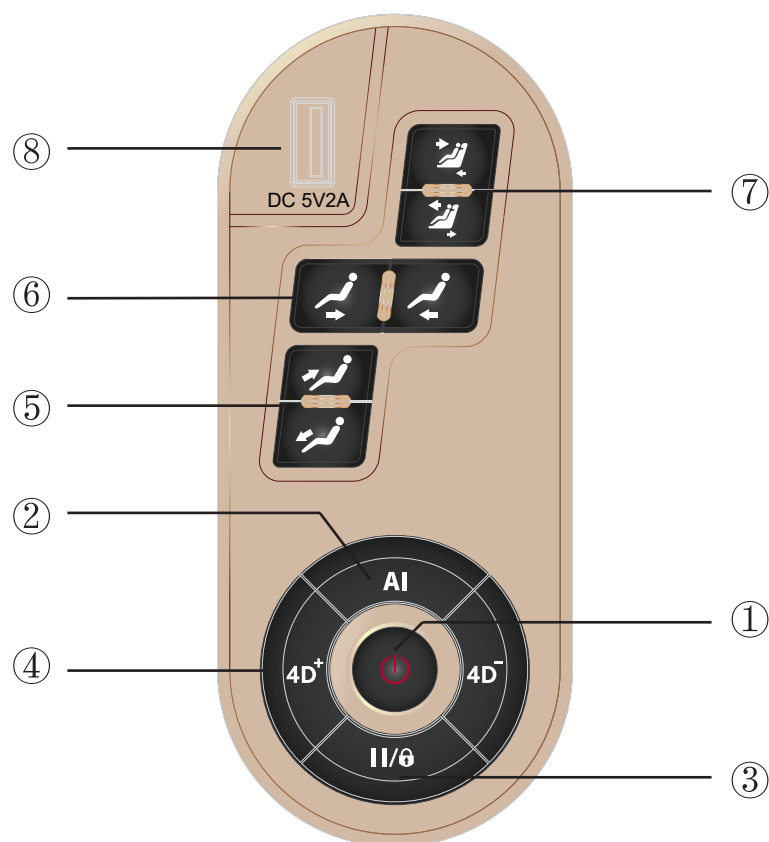

- 1. 【电源】** 开关功能，长按1秒开机，再长按1秒关机。
- 2. 【AI】** 按下 [AI] 按钮时，AI疲劳检测将打开。长按来关闭声控。
【声控】 长按5秒， 关闭声控。再长按5 秒， 开启声控。
- 3. 【暂停】** 按下[暂停]按钮，所有按摩功能将暂时停止，再按一次恢复按摩程序。
【童锁】 长按5秒，童锁开启。要解锁，请按 并保持 5 秒钟。
- 4. 【4D强度调节】** 按[+]键加强4D按摩强度。按 [-] 键减弱 4D强度。
颈部和肩部最多可调整 5 级。腰部和臀部 最多可调整 3 级。
- 5. 【脚部伸/缩】** 按下半部分键， 脚部伸出。按上半部分键， 脚部内缩。
- 6. 【小腿升/降】** 按左键小脚内缩。按右键 小腿脚伸出。
- 7. 【背部仰/躺】** 按下半部分键， 背部仰起。按上半部分键， 背部躺下。
- 8. 【USB口】** 手机充电USB口

操作说明

一. 使用本产品请注意如下事项



1. 将电源插头插入插座，将按摩椅后下部电源开关按至“1”的位置。
2. 按一下平板手控器右上方开关键开机，此时可进行功能选择及操作。
3. 按摩结束之后，按开关键关闭整机按摩功能，此时按摩轮、小腿和靠背会恢复到初始位置。
将按摩椅后下部电源开关按至“0”的位置，并将电源插头从插座中拔除。

1、主页

当按下开/关键时，菜单页面会出现。



这里有10个主要选项：

- 【设置】 此页面允许用户选择语言、语音音量、亮度和银幕休眠
- 【蓝牙】 蓝牙开关键
- 【暂停】 按一下暂停按摩，再按一下恢复按摩
- 【精编】 大师精选，心灵疗愈，气压理疗，AI疲劳检测
- 【5行】 金，木，水，火，土
- 【专业按摩】 心灵理疗 - 脑部按摩- 舒缓，脑部按摩- 专注力，夜晚助眠，深层按摩
保健 - 中医理疗，淋巴排毒，脊椎呵护，关节呵护，瑜伽拉筋
休闲生活 - 运动恢复，舒缓放松，深揉小腿，向心，离心

- 【高级按摩】 手动按摩选项
- 【自定义按摩】 客户可在这里选择想要按摩的部位
- 【气压按摩】 气囊全身按摩或其他部位
- 【座椅调节】 椅子角度调节

2. 设置

用户可以对语言、亮度、音量和睡眠模式进行自己的参考设置。完成后，请点击[X]返回主菜单。



3. 儿童安全锁屏

为安全预防措施，椅子添加儿童安全锁屏。激活后，儿童安全锁屏 会出现。用户需要按住 [Pause] 按钮 5 秒才能解锁。



4. 夹点预防屏幕

防止夹点屏幕显示为另一个在关闭椅子前 / 椅子检测到异物的安全措施。请检查任何异物可能会阻止椅子回到原来的位置。然后按 [OK]以 关闭设备/继续按摩。

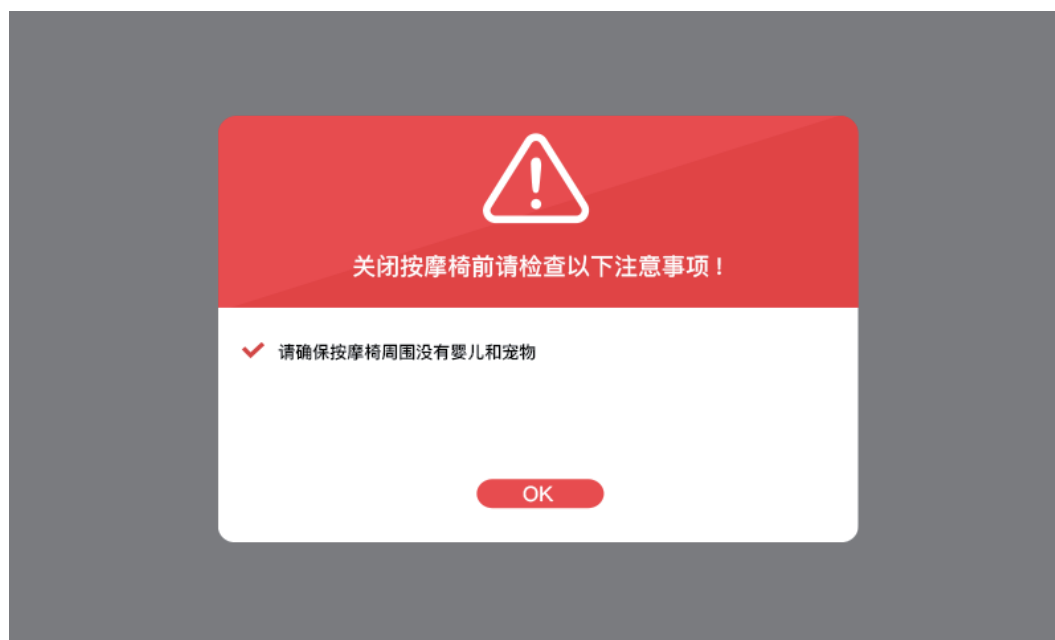

5. 身形检测

激活任何自动或手动程序后，在按摩开始前，椅子会先进行体形扫描。



6. 肩部高度检测

此页面将在人体扫描完成后打开。如果需要，用户可以对肩部位置进行微调。



7. 身形检测错误

在扫描过程中，如果机器检测到由于坐姿或无人操作导致的错误，则会弹出此页面。请重新调整姿势然后按[扫描]进行另一次身体扫描。



8. AI 疲劳检测

当点击AI疲劳检测后，以下银幕会出现。按摩轮会上下行走以收集肌肉僵硬数据再推荐适合的程序。

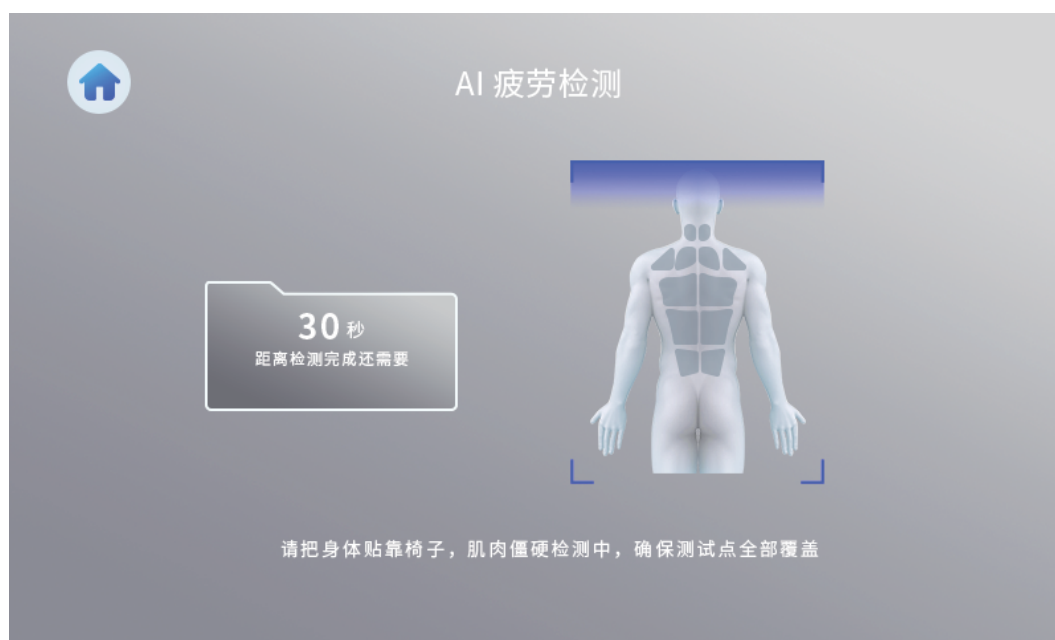

9. 自动按摩

扫描完成后将启动按摩程序，并出现上述页面。



【主页】	主页
【返回】	返回之前页面
【声控】	[声控开关按键
【内置音乐】	内置音乐开关按键
【LED】	LED 页面登入
【暂停】	紧急/临时暂停按键， 再按次按键以继续原来动作
【4D】	当前 4D 等级
【敲击力度】	当前敲击力度
【充气强度】	当前气压强度
【揉捏速度】	当前揉捏速度
【加热】	按摩滚轮和膝盖加热状态
【小腿按摩】	当前小腿按摩状态
【脚轮】	当前脚轮状态

* 以上功能可通过触摸图标进行调整

10. 高级按摩

扫描完成后将启动按摩程序，并出现上述页面。



- 【4D】 触摸图标来提高 4D 等级
- 【敲击力度】 触摸图标可调整力度， 共有5档可调节
- 【充气强度】 触摸图标可调整强度， 共有5档可调节
- 【揉捏速度】 触摸图标可调整速度， 共有5档可调节
- 【温感】 滚轮和膝盖温感弹窗
- 【按摩位置】 按摩定点， 区间， 宽度， 上或下行走弹窗
- 【手法】 多种按摩手法如揉捏， 敲击， 推拿， 指压， 拍打和瑞典式弹窗

* 以上功能可通过触摸图标进行调整

11. 自定义按摩

从身体部位勾选技能，创建自己的按摩程序。

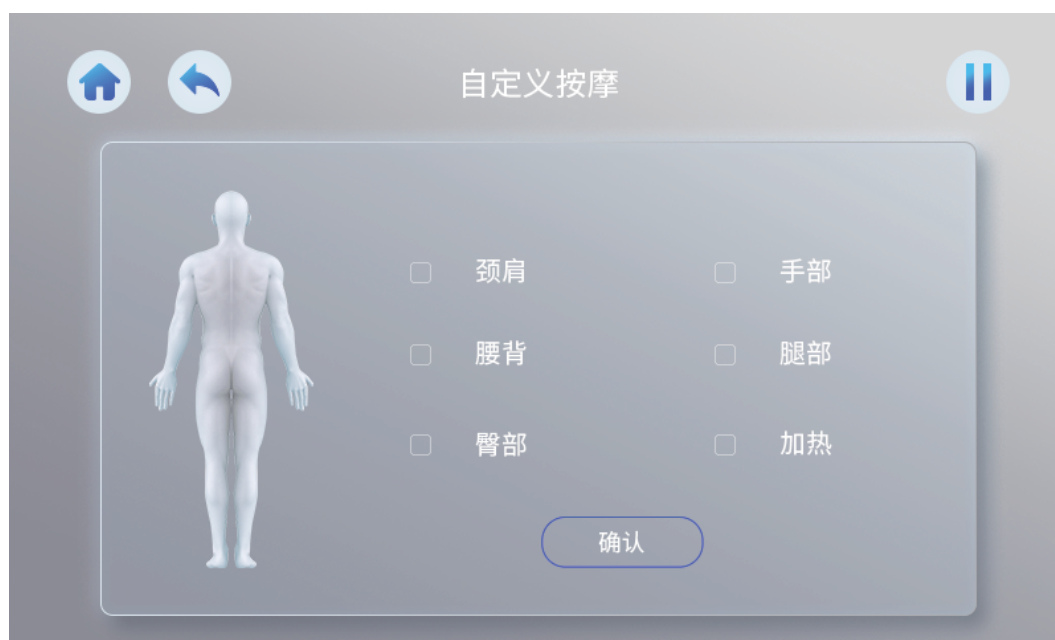

12. 气压按摩

通过触摸屏幕上的图标来选择气压按摩、强度、足部滚轮和小腿按摩所需的区域。



13、座椅调节

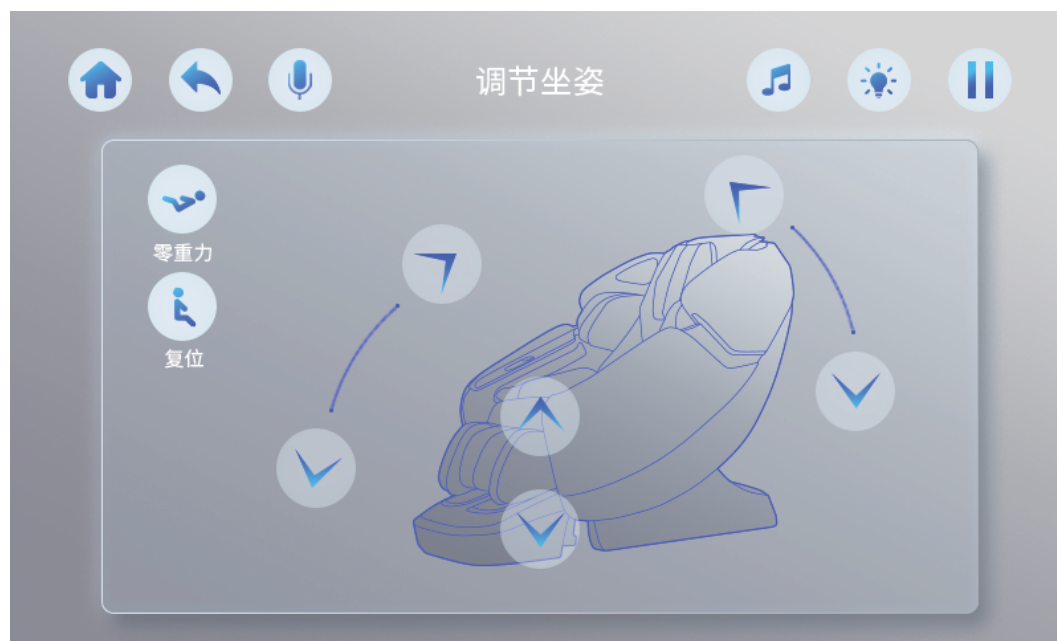

- 【零重力】 零重力角度调整
- 【复位】 回到原点
- 【椅子】 收纳/展开
- 【靠背】 上调/下调
- 【小腿】 上调/下调

14. LED

轻触左上角的 LED 图标，会出现如上的 LED 页面。

触摸以选择任何颜色，再次触摸关闭。负离子开/关也可以从这里选择。



按摩结束

1 使脚部按摩部收回最初位置。

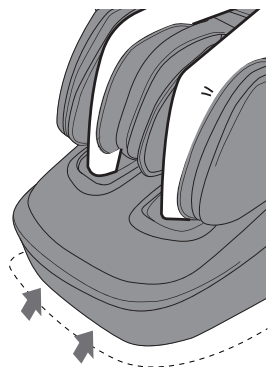

2 将脚从小腿·脚部按摩部上移开。

为确保安全，使用完毕后，请务必收起小腿。

小腿·脚部按摩部的收回方法

- 确认小腿内没有任何物品
- 慢慢地将腿从小腿·腿部按摩部上移开。
在调节页，将小腿调回原点。

3 将平板手控器放回手控器支架上，并嵌入托架。

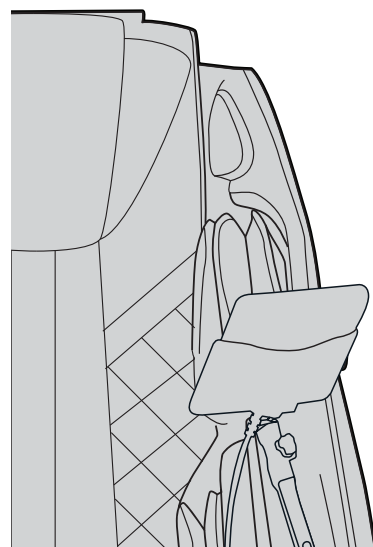

警告

- 儿童禁止使用本机。此外，请勿让儿童或宠物在本体上玩耍，或者爬到小腿脚部按摩部、座面、靠背或扶手上。否则可能会引起事故或造成伤害。

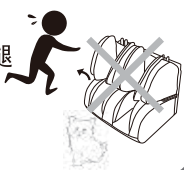

4 切断电源

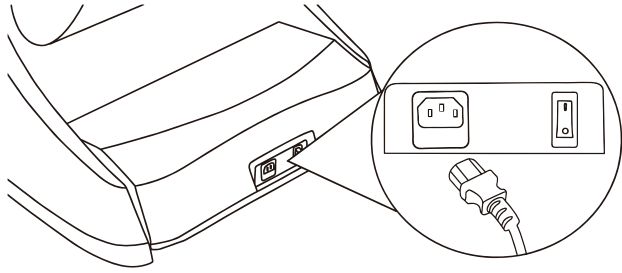

- ① “关闭”电源开关。
- ② 拔下电源插头。

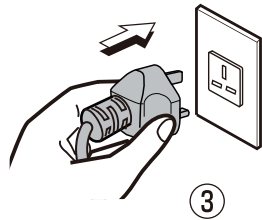

警告

- 每次使用完毕，应将电源开关滑到“0”（关闭）位置，拔掉电源插头。

否则可能因儿童顽皮引发事故或造成伤害。

关于定时器功能

按摩开始后启动定时功能，定时时间到后将自动结束。

- 小腿，脚部按摩部将自动下降。
- 按摩轮将移动到收纳位置。
- 靠背不会自动升起。
如果触摸屏已关闭，按开关键，靠背小腿收回原始位置。

希望中途停止按摩时

按下  按钮

- 小腿，脚部按摩部自动下降，按摩轮退回到收纳位置。
- 按摩轮收起后，靠背升起。

感觉异常时

按下  按钮

- 所有操作将立即停止。
- 小心走下按摩椅，以防按摩椅翻到。

暂停按钮闪烁时

按下  按钮

- 小腿防夹触发后按摩椅暂停键闪烁，按摩椅小腿不动，移开障碍物后按下暂停键才能取消防夹触发，再重选按摩程序。

清洗及保养

清洁合成皮革部分

使用柔软的干布擦拭皮革。

- 切勿使用诸如稀释剂、汽油、酒精等化学品清洁本机。
- 使用市面销售的皮革保养品(抹布)时,请遵照其使用说明。
- 如果合成皮革特别脏,则通过以下方式擦拭。
 - ① 将软布浸入水中或含3%至5%中性洗涤剂的热水中,然后彻底拧干。
 - ② 使用上述软布擦拭皮革表面。
 - ③ 使用浸过清水且已彻底拧干的布料擦掉清洁剂。
 - ④ 使用拧干的软布擦拭。
 - ⑤ 使其自然风干。
- 难以去除污渍时,请将在市面上购买的三聚氰胺泡棉浸入中性洗涤剂中,然后用它擦拭本机。
- 不要使用吹风机吹干表面。
- 由于布料的颜色会染到合成皮革的表面上,因此在使用牛仔布和彩色布料擦拭本机时务必小心。
- 不要使这些部位长时间与塑料接触,因为这会导致褪色。
- 合成皮革有变色的可能,所以在使用染发剂时,请将接触的部分用毛巾覆盖。

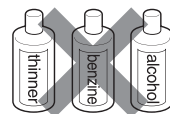
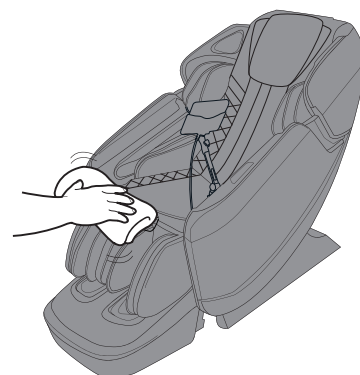

1 将软布浸入水中或含有中性洗涤剂的热水中,拧干后,擦拭本机塑料部。

- 切勿使用诸如稀释剂、汽油、酒精等化学品清洁本机。

2 使用浸有清水且已彻底拧干的布料擦拭。

- 擦拭遥控器前请务必拧干布料。

3 使其自然风干。

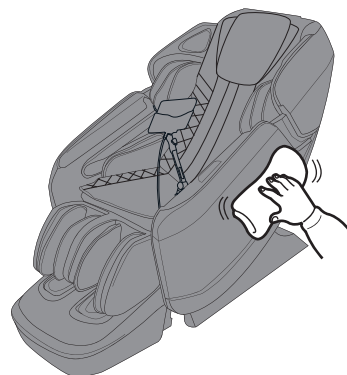

疑问解答(Q&A)

Q 因为生病而经常出入医院的人可以使用本品吗？

A 经常出入医院的人，请在与医生商量的前提下使用本品。

按摩即所谓“触压刺激”，即通过对肌肉进行压迫，缓解肌肉紧张，促进血液流动。根据不同的病因，按摩有可能造成病情恶化，因此请务必在和主治医师商量之后使用本品。

Q 身高多少的人适合使用本品？

A 根据体型的不同多少会有所差异。请大致参考下文使用本品。

- 身高小于145 cm的用户，及身高超过185 cm的用户同时使用上半身按摩和小腿·脚部按摩时，可能出现足底与脚部按摩部接触不充分，或膝盖弯曲的情况。

身高较高的用户感觉膝盖部位弯曲时

请选用下述方法**A**或方法**B**

- A** 放倒靠背，降低小腿·脚部按摩部位置。
- B** 利用腿置台，只对上半身进行按摩。
(足部按摩与上半身按摩分开使用)

身高较矮的用户难以向下触到足底按摩部时

请选用下述方法**A**或方法**B**

- A** 抬起靠背，升高小腿·脚部按摩部位置。
- B** 利用腿置台，只对上半身进行按摩。
(足部按摩与上半身按摩分开使用)

Q 搬家时，有什么需要特别注意的地方？

A 请注意以下事项。

- 为了方便搬运，请先将按摩椅靠背倾斜到最低位置。
- 搬运时，人不要坐在座椅上。

① 按下开机键，接通电源。

② 按下  使靠背呈完全倾斜状态。

再按下此按钮
靠背和小腿停此移动。

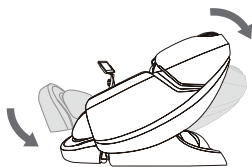

③ 关闭电源开关，拔出电源插头。

- 在有原装纸箱的情况下，请先确认电源线未被缠绕在本机上，将电源线缠好放在座面上；搬运的时候，请注意电源线没有掉落且未与地面发生摩擦。
- 在没有原装纸箱的情况下，为了防止机体划伤和搬运中的震动，请妥善使用其它包装辅材包裹本品。

Q 请问在哪里可以看到产品的制造编号？

A 在按摩椅主体背面的座面下。

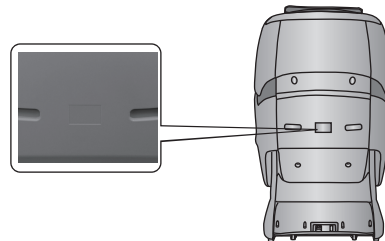

Q 未从膝部感受到温热怎么办？

A 「膝盖温热」只有膝盖部位的布料有温热感。请将膝盖紧贴在温感传递部。脚部按摩部分抬高时，膝盖与温感传递部紧密接触，使用户感到温暖。另外，用户可以通过用毛毯盖住膝盖，增加温暖感。

Q 有点在意按摩椅运作时发出的声音……

A 按摩椅运作时产生的声音，一般是由于机芯构造而发出的。

Q 按摩中感觉左右两边按摩轮的按摩力度有差异，要紧吗？

A 由于机芯构造，在按摩过程中，确有可能感觉左右按摩轮的力度有差异。

为了能够模拟出最自然的按摩手法，本品机芯采用了允许左右按摩轮交替捶背的机芯构造。在按摩过程中，左右按摩轮接触背部的具体位置可能稍有差异，从而导致了使用者产生左右两侧按摩力度有所不同的感觉。此时，本品本身并未发生故障。

Q 感到足底指压过于用力……

A 使用气囊按钮将气囊强度设置为“1”。另外，降低小腿·脚部按摩部，也可以减轻足底的指压力度。

Q 使用本品时每个月耗电量是多少？

A 按每日30分钟，使用频率来计算，每月本品耗电量约为2.5度。

发现故障后，首先检查并尝试以下方法。
如果在尝试后，故障依然存在，请联系销售店。

问 题	原因和解决方法
<p>在使用本机过程中按摩轮停止 (按摩椅发出“哔哔”的声音，遥控器上所有的显示图标和按钮闪烁然后熄灭)</p>	<p>在使用过程中，按摩轮遇到过大的外力时，出于安全考虑，按摩轮可能会停止移动。 如果遥控器上的所有标记和按钮开始闪烁，这种情况极为异常，请关闭电源开关，等待约10秒钟，然后再次打开电源。 如果按摩轮再次停止，请调整自己的坐姿，不要使背部完全贴在靠背上。(应注意遵守相关注意事项，尤其在体重为100 kg或以上的人使用时。)</p>
<p>不能倾斜 小腿不能升高降低 (发出“哔哔”的声音，遥控器的运行指示灯熄灭并停止运行)</p>	<p>如果本机遇到了障碍物或者在使用本机时用力过大，出于安全考虑，本机将停止工作。 当所有显示的内容及按钮在闪烁时，且靠背或小腿已停止工作，关闭本机电源一次，约10秒钟后再次打“开启”电源，然后操作本机。</p>
<p>按摩轮没有达到肩部或颈部的位置</p>	<p>如果头部没有接触到靠枕，或背部没有接触到靠背，在体型检测过程中肩部位置可能低于实际位置。坐在座椅的最深位置，将头部靠在靠枕上，然后从头开始重新操作。</p>
<p>左右按摩轮的高度(强度)不同</p>	<p>因为搭载了可进行按摩轮交互捶拍动作的按摩机芯，出现这种情况纯属自然。并非机体故障。</p>
<p>本机根本无法运行。 ●上半身(颈部至腰部)按摩 ●小腿和脚部按摩</p>	<ul style="list-style-type: none"> ● 电源线连接已断开。 ● 没有打开本机电源开关。 ● 按下遥控器上的开机键按钮后，没有选择任何程序。
<p>按摩轮和膝盖温感都没有温热感</p>	<ul style="list-style-type: none"> ● 按摩轮和膝盖温感按钮被设定为关闭状态。 ● 膝部温感只有膝盖部位的布料有温热感。 温感的感知程度根据用户的体型，按摩手法，衣服，室温而有所不同。脚部按摩部分抬高时，膝盖与温感传递部紧密接触，使用户感到温暖。另外，用户可以通过用毛毯盖住膝盖，增加温暖感。
<p>即使关闭温热功能，温度也将不下来</p>	<ul style="list-style-type: none"> ● 由于加热器的结构，加热后片刻依然会因为余热而感到温暖。 ● 即使关闭温热功能，持续按摩同一部位，也会使体感温度上升。
<p>即使按下按摩轮和膝部温感，加热器也不发热</p>	<p>如果上半身按摩或膝盖按摩部都没有加热，温热功能无法单独使用。</p>
<p>本机已受损</p>	<p>为防止事故发生，请务必与授权服务中心联系。</p>
<p>电源线或电源插头异常发热</p>	<p>为防止事故发生，请务必与授权服务中心联系。</p>

若以上处理方法无效，请联系OGAWA服务中心 1-800-88-4688。

关于运行过程中本机发出的声音和令人在意的感觉

在使用中会发生下述动作音、感觉，不过这是因按摩椅的结构而发生的，并非异常。

- 按摩轮由“伸出”改为“收回”时的声音
- 动作时按摩轮擦过面料上的皱纹时发出的声音和感觉
- 揉按、捶拍动作等的动作音
- 按摩轮动作时的摩擦声
- 上下动作时的动作音
- 传送带的转动音
- 电机音
- 按摩轮从“挤压”改为“拉伸”时的声音
- 落座时的声音
- 靠背倾斜时扶手与靠垫的摩擦声
- 按摩轮与布料的摩擦声
- 气囊按摩运作时的充气泵工作音
- 气囊按摩运作时的排气音
- 气囊按摩运作时座椅下电磁阀发出的工作音。
- 腿置台的晃动
- 肩部伸展、动作时的声音
- 气囊的动作音
- 脚部按摩部的滑动音
- 靠背倾斜时，靠垫与后盖皮革摩擦时发出的声音

当声音变大时，也有可能发生了故障。

- 此时，请委托授权服务中心进行检查和修理。

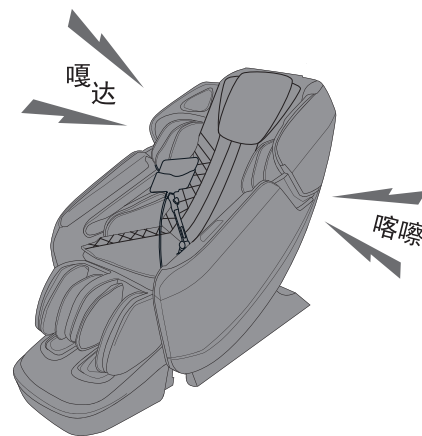

警告

- 请勿擅自改造本机。请勿自行分解或修理本机。否则可能导致起火、异常动作、人身伤害。

警告

- 发生异常、故障时，立即停止使用，拔掉电源插头。（否则可能冒烟、起火、触电）
〈异常、故障事例〉
 - 接通电源开关后可能不动作
 - 移动电源线，有时通电有时不通电
 - 运行中发出焦臭味、异常声响
 - 按摩椅变形或者异常发热→ 请立即委托授权服务中心检查和修理。

规格

产 品 型 号		OG7599	
产 品 名 称		MAESTRO	
电 源		AC 220-240V~, 50-60Hz	
消 耗 电 力		150W	
上 半 身 按 摩	可 按 摩 范 围 (上下方向)	约1.35m	
	可 按 摩 范 围 (左右方向)	在使用本机过程中按摩轮间的距离(包括按摩轮的宽度) 背部滚动和上下移动过程中按摩轮间的距离(包括按摩轮的宽度): 约 4.5cm~18.5cm	
	可 按 摩 范 围 (前后方向)	按摩轮的突出量(强度可调节) 约9.5cm	
	按 摩 速 度	揉按 约19次/分钟~约36次/分钟 捶拍 约267次/分钟~约438次/分钟(单侧) 移动速度 约2.5cm/秒~约3.5cm/秒	
倾 斜 角 度		靠背: 约 128° ~ 154° 小腿按摩部分: 约 7.8° ~ 66.5°	
自 动 关 闭		约15分钟(自动断电)	
尺 寸	未 倾 斜 时 (高×宽×长)	约 161cm x 78cm x 122cm	
	倾 斜 时 (高×宽×长)	约 203cm x 78cm x 116cm	
椅 架	净重: 92.6kg 毛重: 111.5kg	外箱尺寸: 134cm x 83.5cm x 126.5cm	
小 腿	净重: 23.4kg 毛重: 26.5kg	外箱尺寸: 57cm x 55cm x 57.5cm	
重 量		约116kg	
用 户 最 大 体 重		约100kg	

对于体重100 kg 或以上的人士, 产品运作时可能产生更大的噪声而且面料外罩可能磨损得更快。

客户服务指南

保修指南

按摩椅内饰件
主板、板件、电机、气泵
内布线/气管

保修以外

皮革
织物、产品部件、外罩板等的任何褪色或变质因个人使用造成的

控制器
因个人使用造成的屏幕破碎、控制器损坏等

*操作噪音并不意味着产品出现故障

保修以外

保修以外用于以下情况。

- 01 由于液体溅入产品内部而导致的问题。
- 02 因使用压力过大导致零件损坏或失效。
- 03 因个人行为造成的变形或外部缺陷造成的问题。
- 04 由于未使用 OGAWA 提供的部件或电线而导致的问题。
- 05 产品使用不当导致的问题。
- 06 用户特意堵转机器部件引起的问题。
- 07 非OGAWA技术人员维修造成的问题。
- 08 自然灾害引起的问题。
- 09 未遵循用户手册中所述的安全预防措施。
- 10 个人误用造成的问题。
- 11 因用户鲁莽行为、无法遵循准则而导致的问题，等等。

*如果评估结果确定问题不是用户的过错，将提供保修。

联系我们



MALAYSIA
Healthy World Lifestyle Sdn Bhd
No. 22 Jalan Anggerik Mokara 31/47
Kota Kemuning, 40460 Shah Alam
Selangor Darul Ehsan, Malaysia
Tel : +603-5121 4286
Fax: +603-5121 4386



HONG KONG, CHINA
OGAWA Health Care International (HK) Ltd
31/F, YHC Tower, 1 Sheung Yuet Road
Kowloon Bay
Kowloon
Hong Kong
Tel: +852 3465 6262
Fax: +852 2410 0119



SINGAPORE
OGAWA Health-Care Pte Ltd
27 Tampines Industrial Avenue 5,
T5 @ Tampines
Singapore 528623

Tel: +065-6846 8588
Fax: +065-6846 7677



VIETNAM
OGAWA Vietnam Co Ltd
2nd floor, Petroland Tower,
12 Tan Trao, Tan Phu ward
District 7
Ho Chi Minh
Tel: +84 8 3775 3093/3775 3094
Fax: +84 8 3775 3095



PHILIPPINES
O-Healthcare Solution Phil. Inc.
2303, 4th Floor, G&A Building,
Chino Roces Avenue Extension,
Makati City, Philippines
Tel : +632 889 0676 / +632 844 6851
Fax: +632 812 0421

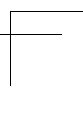
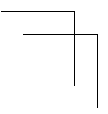
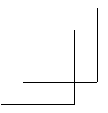

Ogawa is grateful
to have received
these awards:



Ogawa Wellness Hubs : Malaysia . Singapore . Vietnam . Philippines . Indonesia . Myanmar . India . China
Hong Kong . Taiwan . Turkey . Pakistan . Mauritius . Russia . France . Canada
Thailand . Korea . Australia . Dubai . K.S.A . Nigeria . Egypt . Lebanon . Denmark
Sweden . U.S.A